

BONE HOLDING INSTRUMENTS

Bone holding instruments are essential for maintaining stable positioning of bone fragments during orthopedic procedures. Our range includes forceps, clamps, and graspers designed for a secure, non-slip hold without causing damage to bone surfaces. Precision-engineered from surgical-grade materials, these instruments ensure firm control, ease of handling, and reliability throughout the surgical process.



BONE HOLDING FORCEPS

LEWIN BONE HOLDING FORCEPS



CODE #	DESCRIPTION
ML47130	Serrated, 7" (18 cm)

BONE HOLDING FORCEPS

For positioning K-Wire up to 0.062" (1.6 mm).



CODE #	DESCRIPTION
ML45304	Curved, with 0.062" (1.6 mm) K-wire guide, 5-1/2" (14 cm)

BONE HOLDING FORCEPS

For positioning K-Wire up to 0.035" (0.9 mm).



CODE #	DESCRIPTION
ML45302	Curved, with 0.035" (0.9 mm) K-Wire guide, 6-3/4" (17 cm)

BONE HOLDING FORCEPS

Curved, with K-Wire guide, 5" (13 cm).



CODE #	DESCRIPTION
ML45305	0.035" (0.9 mm)
ML45306	0.045" (1.1 mm)
ML45307	0.062" (1.6 mm)

GLENOID PERFORATING FORCEPS

Pointed tips, 6-1/2" (17 cm).



CODE #	DESCRIPTION
ML46911	Slightly curved
ML46912	Strongly curved

BONE HOLDING FORCEPS

Angled, with fenestration.



CODE #	DESCRIPTION
ML47129	Inside fenestration 22 x 14 mm, outside fenestration 30 x 20 mm, ratchet length 3" (76 mm), overall length 6" (15 cm)

LOCKE PHALANGEAL FORCEPS

Very useful for removing the sesamoid bone

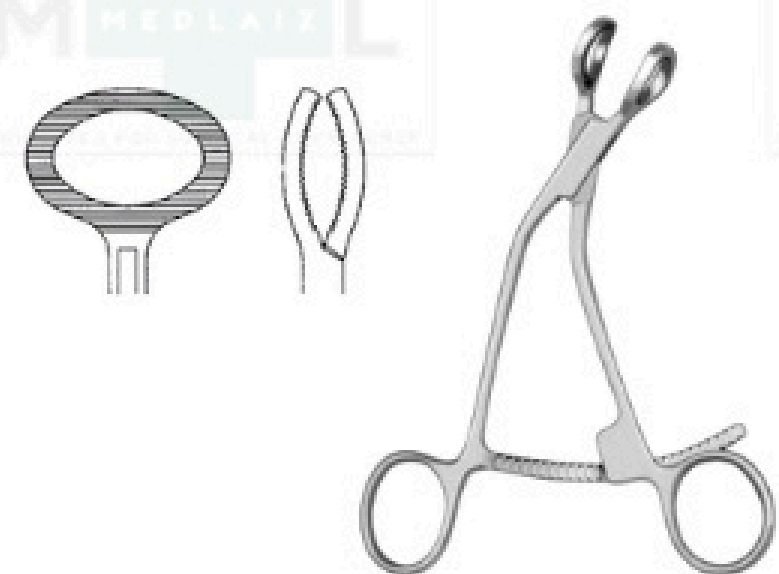

CODE #	DESCRIPTION
ML69787	Serrated, 1 x 2 teeth, 6" (15 cm)

PLATE AND BONE HOLDING FORCEPS

For positioning mini bone plates.



CODE #	DESCRIPTION
ML47139	1 pointed tip, 5-1/4" (14 cm)

MALLEOLAR BONE HOLDING FORCEPS

Grasping forceps for small bones



CODE #	DESCRIPTION
ML47010	1 x 1 sharp points, 8-1/4" (21 cm)

PLATE AND BONE HOLDING FORCEPS

For positioning small bone plates.



CODE #	DESCRIPTION
ML47138	5-3/8" (14 cm)

PARHAM-MARTIN BONE CLAMP

Fit thin end of band through slot in other end of band. Insert thin end into clamp. 8-1/4" (21 cm).



CODE #	DESCRIPTION
ML47172	Bands not included
ML47173	Single band only

SEMB BONE HOLDING FORCEPS

Curved sideways. Deep teeth.



CODE #	DESCRIPTION
ML47074	4 x 5 teeth, without ratchet, 7-1/2" (19 cm)
ML47076	5 x 5 teeth, with ratchet, 8" (21 cm)

PATELLA BONE HOLDING FORCEPS

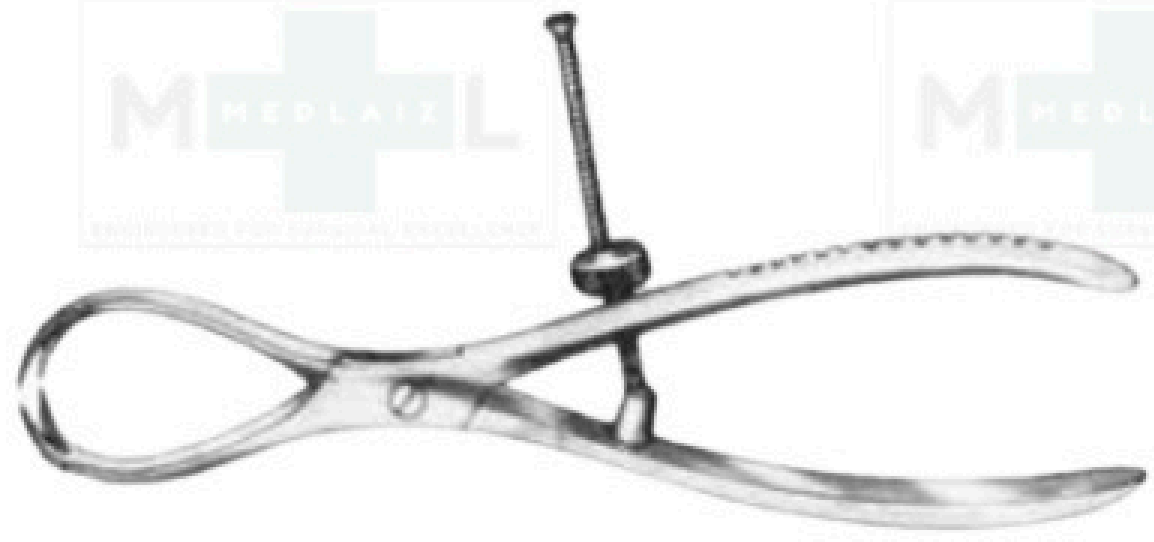

CODE #	DESCRIPTION
ML47012	2 x 2 sharp teeth, with speed lock, 7" (18 cm)

FARABEU F BONE HOLDING FORCEPS

Adjustable jaw

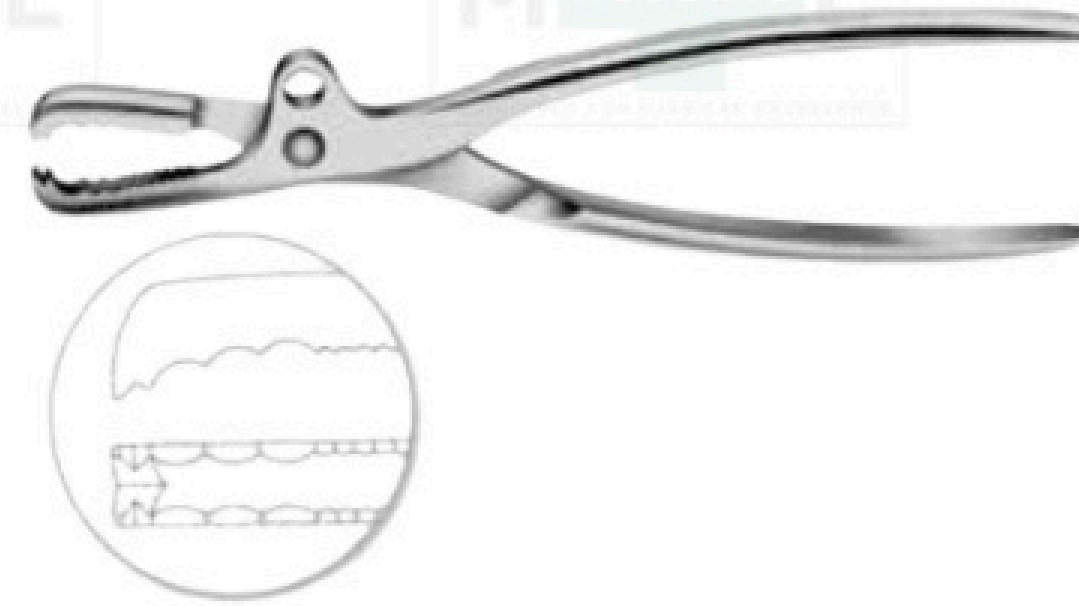

CODE #	DESCRIPTION
ML47194	9" (23 cm)
ML47196	10" (25.5 cm)

LANGENBECK BONE HOLDING FORCEPS



CODE #	DESCRIPTION
ML47200	2 x 2 sharp teeth, with speed lock, 7" (18 cm)

FARABEU-F-LAMBOTTE BONE HOLDING FORCEPS

Adjustable jaw



CODE #	DESCRIPTION
ML47190	7-1/2" (19 cm)
ML47192	10-1/2" (27 cm)

VAN BUREN SEQUESTERUM FORCEPS

Curved sideways, serrated, 9" (23 cm)



CODE #	DESCRIPTION
ML47072	2 x 2 teeth, 8-1/4" (21 cm)

FIBULA BONE HOLDING FORCEPS

With angled tip and speed lock.



CODE #	DESCRIPTION
ML47170	8-1/2" (22 cm)

FIBULA BONE HOLDING FORCEPS

With angled tip and speed lock.



CODE #	DESCRIPTION
ML47170	8-1/2" (22 cm)

LAMBOTTE BONE HOLDING FORCEPS

With swivel head, adjustable jaw.



CODE #	DESCRIPTION
ML47204	8-1/2" (22 cm)
ML47206	10-1/2" (27 cm)
ML47208	11-1/2" (29 cm)

FERGUSON BONE HOLDING FORCEPS



CODE #	DESCRIPTION
ML47198	Deep teeth, 8-1/4" (21 cm)

ULRICH SELF-RETAINING BONE HOLDING FORCEPS

Straight, with speed lock.



CODE #	DESCRIPTION
ML47108	Mini, 7-1/4" (19 cm)
ML47110	8-1/2" (22 cm)
ML47112	9-7/8" (25 cm)
ML47114	10-1/4" (26 cm)

KERN BONE HOLDING FORCEPS



CODE #	DESCRIPTION
ML47054	Mini, 6-5/8" (17 cm), without ratchet
ML47056	9-1/2" (24 cm), without ratchet
ML47062	6-3/4" (17 cm), with ratchet
ML47064	9-1/2" (24 cm), with ratchet

LANE BONE HOLDING FORCEPS

Particularly well suited for use during insertion of intermedullary nails.

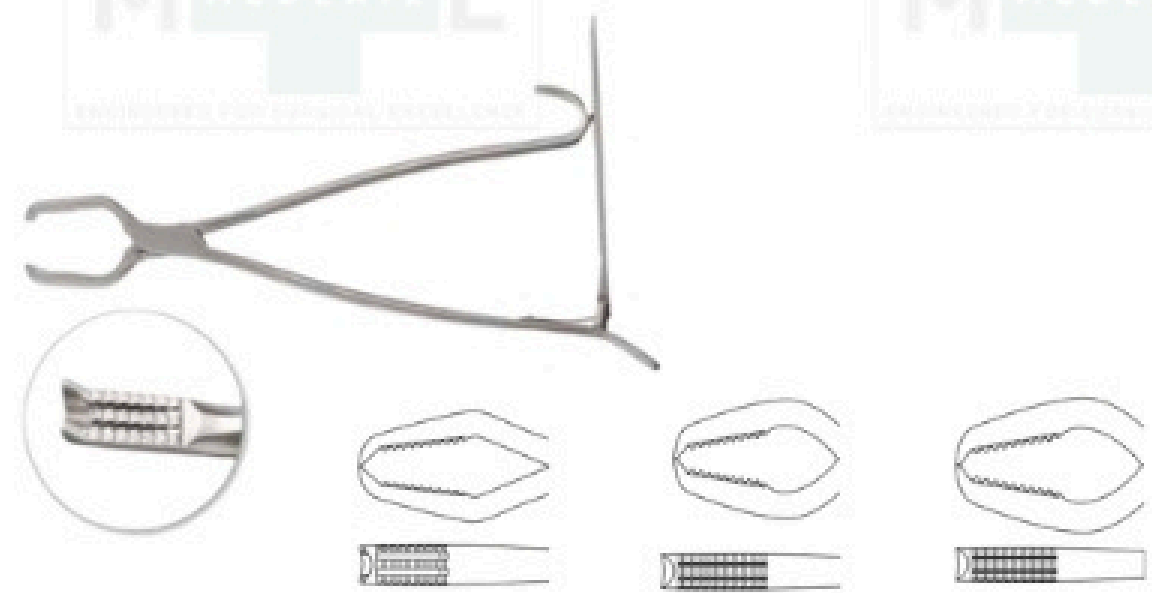

CODE #	DESCRIPTION
ML47078	Light model, without ratchet, 13" (33 cm)
ML47080	Light model, with ratchet, 13" (33 cm)
ML47068	Standard model, without ratchet, 13" (33 cm)
ML47082	Standard model, with ratchet, 13" (33 cm)
ML47070	Without ratchet, 17" (43 cm)
ML47084	With ratchet, 17" (43 cm)

VEBRUGGE SELF-CENTERING BONE HOLDING FORCEPS

Self centering, with speed lock



CODE #	DESCRIPTION
ML47090	5-3/4" (15 cm)
ML47092	7-1/4" (19 cm)
ML47094	9-1/4" (24 cm)
ML47096	10" (26 cm)
ML47098	11-1/4" (29 cm)

ULRICH SELF-RETAINING BONE HOLDING FORCEPS

Angled, with speed lock and swivel jaw



CODE #	DESCRIPTION
ML47118	11" (28 cm)

ULRICH SELF-RETAINING BONE HOLDING FORCEPS

Angled, with speed lock.



CODE #	DESCRIPTION
ML47109	7-1/4" (19 cm)
ML47116	11" (28 cm)

ANGLED BONE HOLDING FORCEPS

With swivel head, adjustable jaw.



CODE #	DESCRIPTION
ML47212	8-1/2" (22 cm)

VERBRUGGE BONE HOLDING FORCEPS

With short ratchet



CODE #	DESCRIPTION
ML47120	6-7/8" (18 cm)

VERBRUGGE BONE HOLDING FORCEPS

With long ratchet.

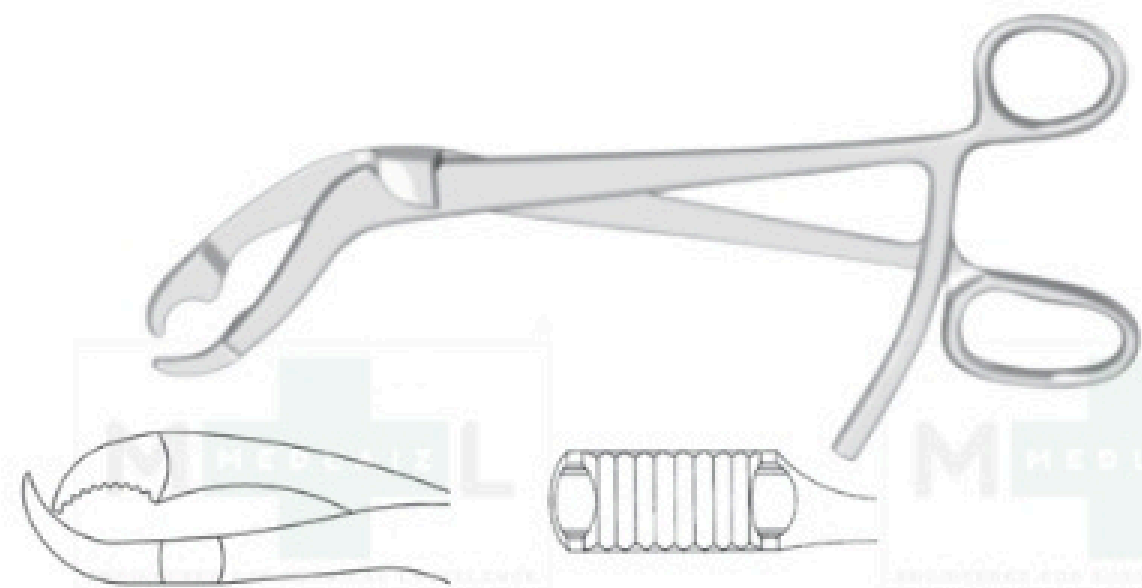

CODE #	DESCRIPTION
ML47122	10" (26 cm)
ML47124	10-1/2" (27 cm)
ML47126	11" (28 cm)

BONE REDUCTION FORCEPS

STAGBEETLE BONE REDUCTION FORCEPS



CODE #	DESCRIPTION
ML47119	Curved, pointed tips, 4-7/8" (13 cm)

BONE REDUCTION FORCEPS

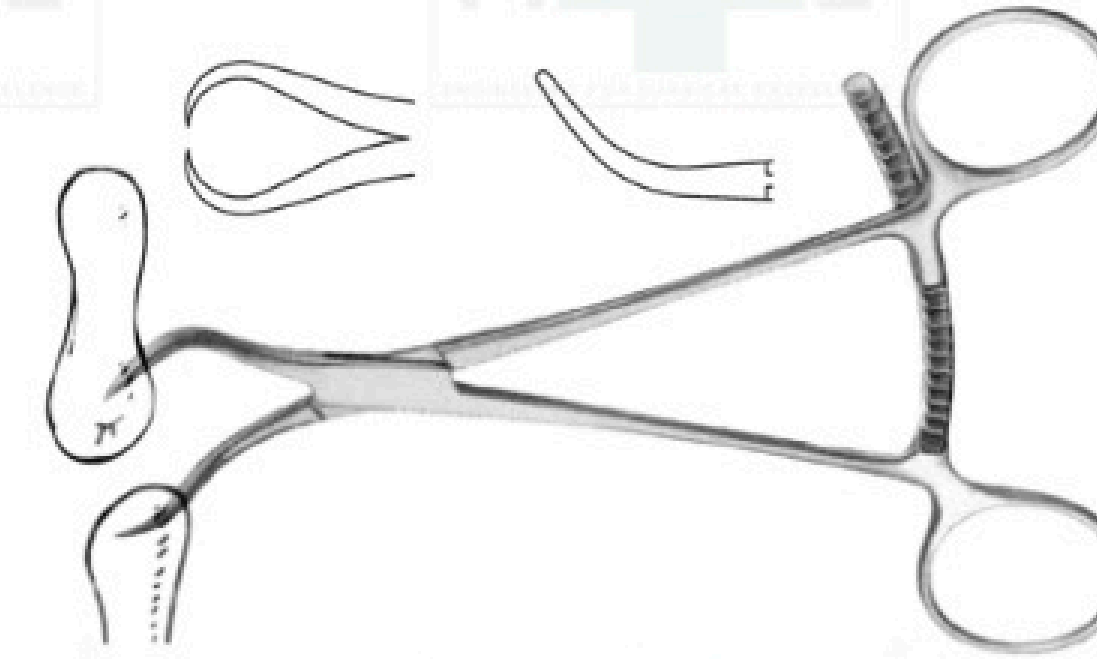

CODE #	DESCRIPTION
ML45300	Curved, pointed tips, 5" (13 cm)

BONE REDUCTION FORCEPS

Curved. One tip has a stepped point for a better hold on bone.

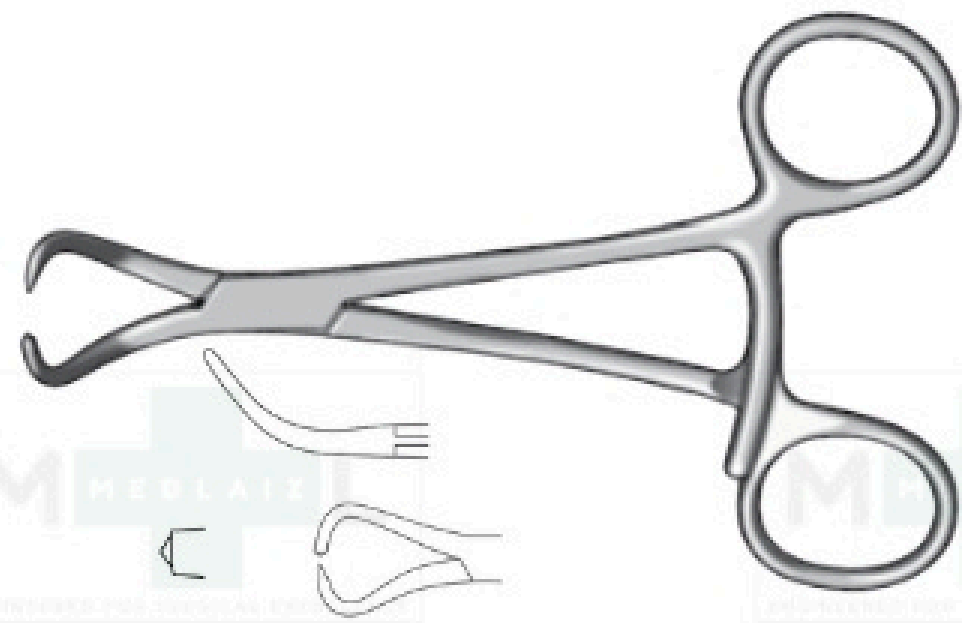

CODE #	DESCRIPTION
ML47137	5-1/4" (14 cm)
ML47136	6-3/4" (17 cm)

BONE REDUCTION FORCEPS

With ratchet completely engaged, the jaw opening is 9 mm wide.



CODE #	DESCRIPTION
ML47134	Ratchet length: 2" (5 cm) Opens to 4" (10 cm) 8" (21 cm)

REILL BONE REDUCTION FORCEPS

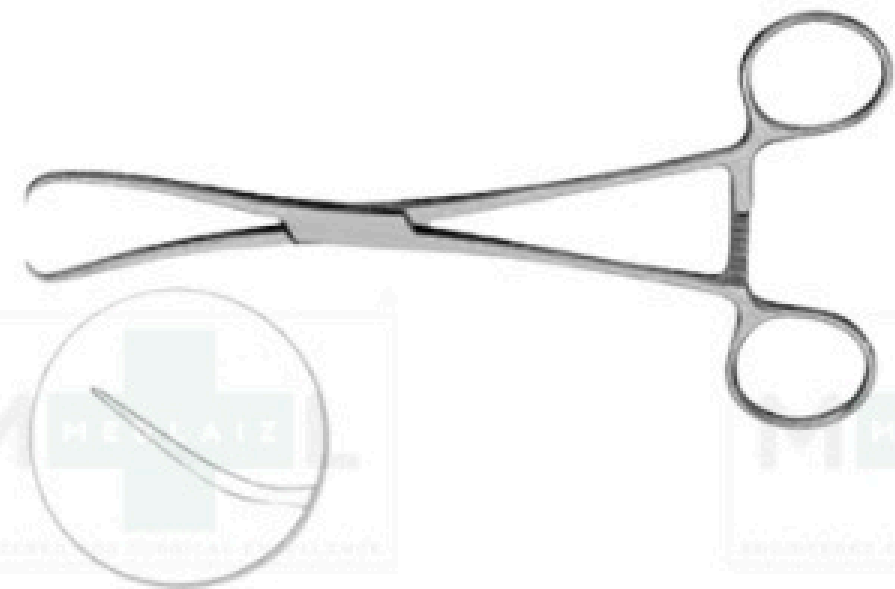

CODE #	DESCRIPTION
ML47132	Curved, pointed tips, 6-3/4" (17 cm)

BONE REDUCTION FORCEPS

Curved, with speed lock

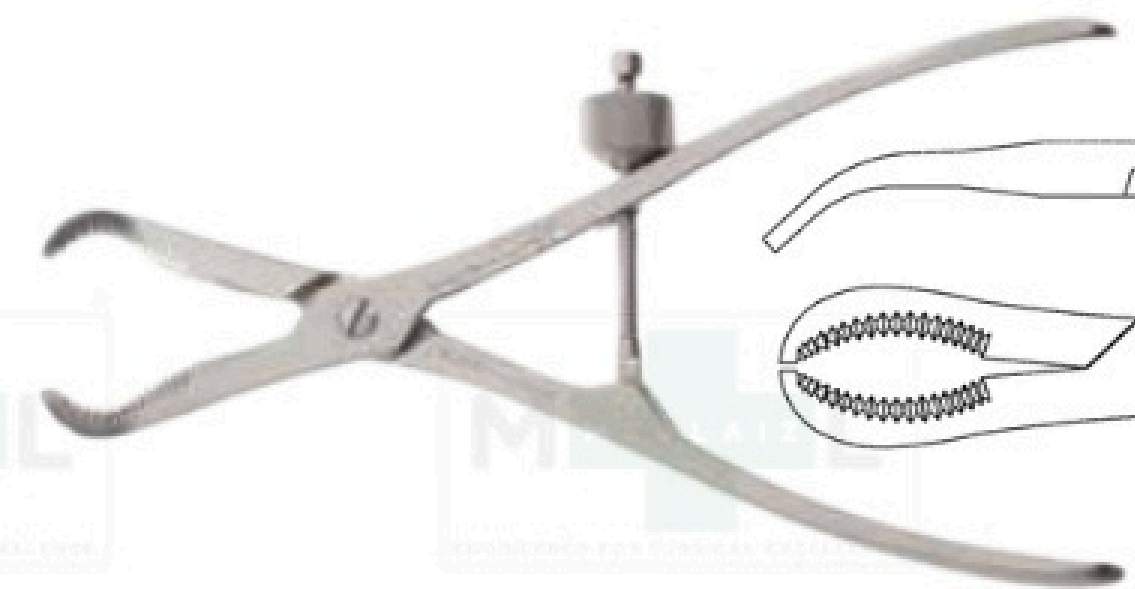

CODE #	DESCRIPTION
ML47105	7" (18 cm)
ML47135	9-5/8" (25 cm)

BONE REDUCTION FORCEPS

Curved and serrated with pointed tips.



CODE #	DESCRIPTION
ML47133	Narrow, 5-1/4" (14 cm)
ML47135	Broad, 5-1/2" (14 cm)

ASYMMETRIC PELVIC REDUCTION FORCEPS



CODE #	DESCRIPTION
ML45310	Short pointed-ball tips, 16" (41 cm)

BONE REDUCTION FORCEPS



ANGLED PELVIC BONE REDUCTION FORCEPS

Long tips



CODE #	DESCRIPTION
ML45314	Long pointed-ball tips, 9-5/8" (25 cm)

ANGLED PELVIC BONE REDUCTION FORCEPS

Short tips

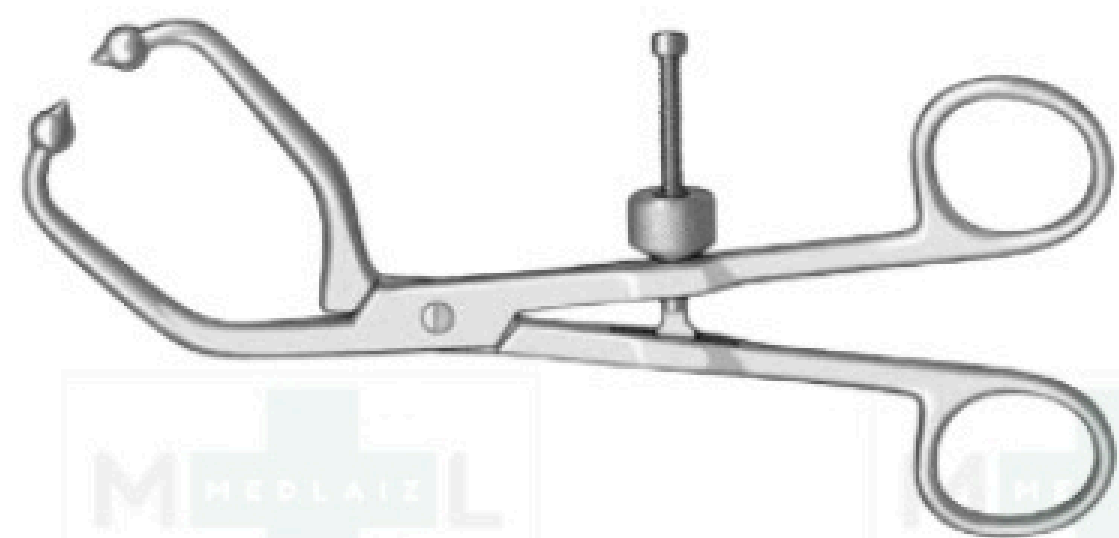

CODE #	DESCRIPTION
ML45312	Short pointed-ball tips, 7-3/8" (19 cm)

PELVIC REDUCTION FORCEPS



CODE #	DESCRIPTION
ML47100	With screws, 13-1/2" (35 cm)

PELVIC REDUCTION FORCEPS

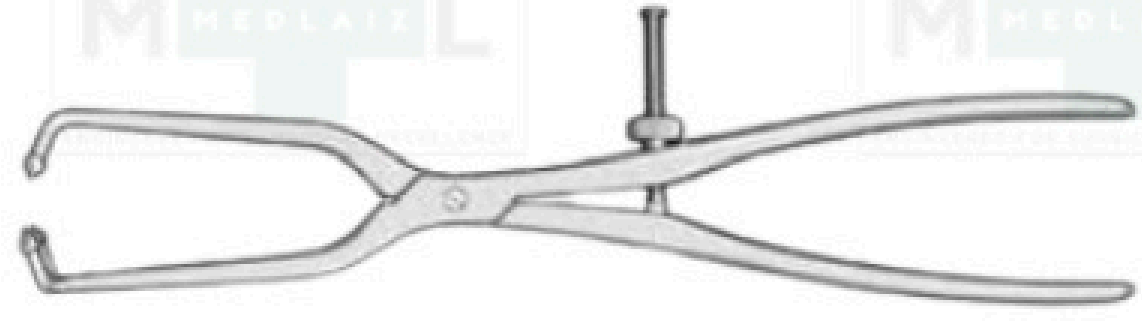

CODE #	DESCRIPTION
ML47101	1 x 2 jaws, long pointed-ball tips, 16-1/8" (41 cm)

PELVIC REDUCTION FORCEPS

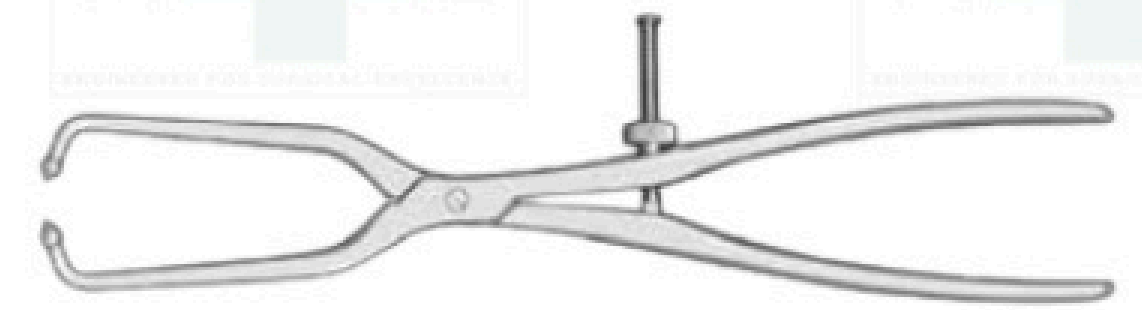

CODE #	DESCRIPTION
ML47103	Pointed tips, long pointed-ball tips, 16-1/8" (41 cm)

PELVIC REDUCTION FORCEPS

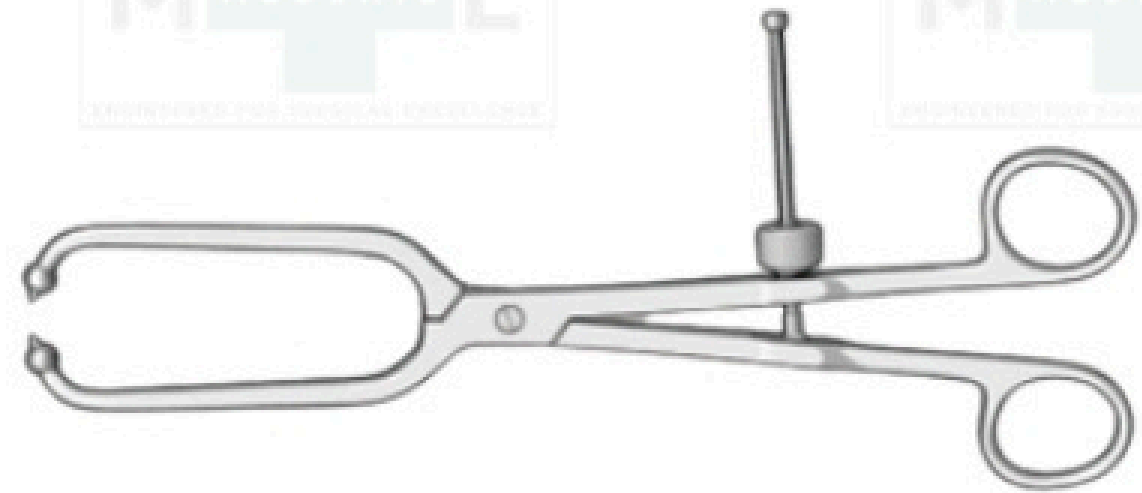

CODE #	DESCRIPTION
ML47102	Angled tips, short pointed-ball tips, 10-1/8" (26 cm)

BONE CLAMPS

BISHOP BONE CLAMP



CODE #	DESCRIPTION
ML47202	Adjustable jaw, 8-7/8" (22.5 cm)

LOWMAN BONE CLAMPS

1 x 2 jaws. Calibrated in inches to measure bone diameter.



CODE #	DESCRIPTION
ML47140	4-3/4" (12 cm)
ML47154	5-5/8" (14.5 cm)
ML47156	6-3/4" (17 cm)

LAMBERT-LOWMAN BONE CLAMPS

2 x 2 jaws. Calibrated in inches to measure bone diameter.

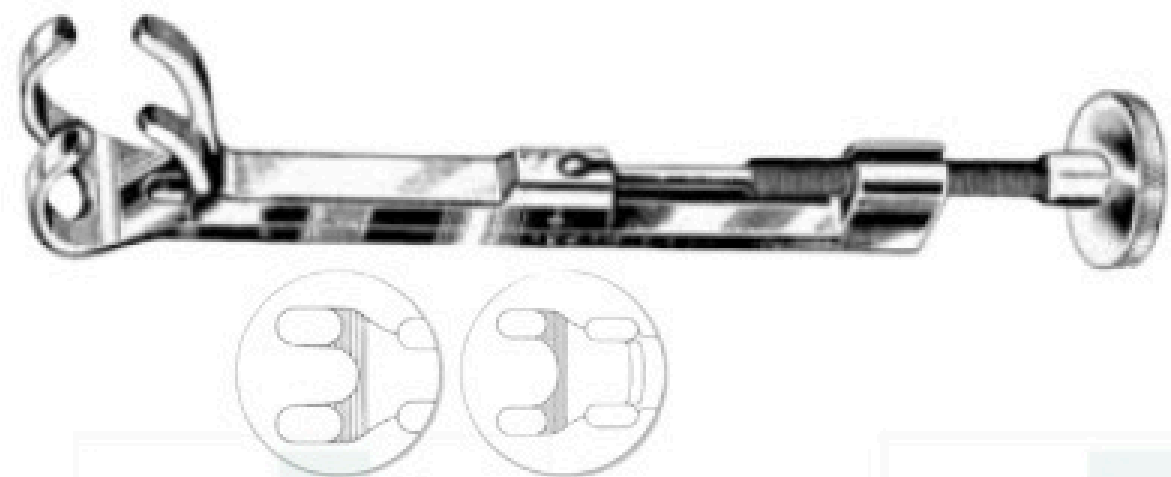

CODE #	DESCRIPTION
ML47167	7-1/4" (18.5 cm)
ML47168	8" (20.5 cm)

LOWMAN BONE CLAMPS

1 x 1 jaws. Calibrated in inches to measure bone diameter.

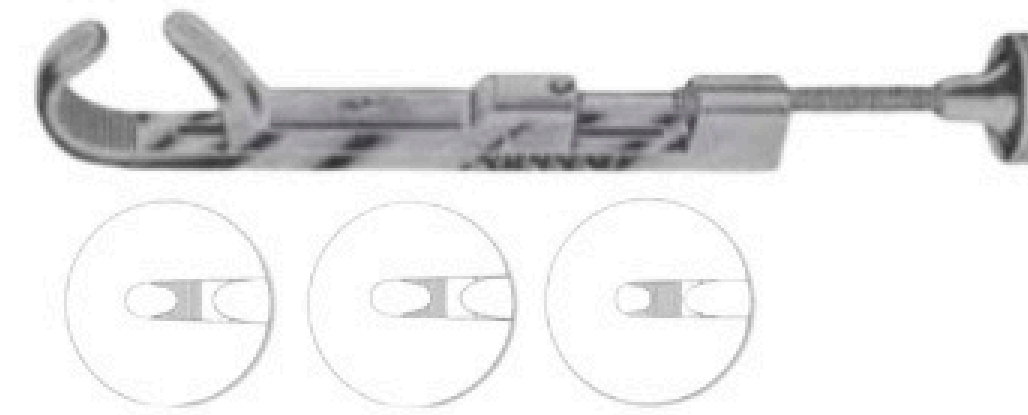

CODE #	DESCRIPTION
ML47160	4-3/4" (12 cm)
ML47164	5-3/4" (14.5 cm)
ML47166	6-7/8" (17.5 cm)

ROSENBLOOM SESAMOID CLAMP

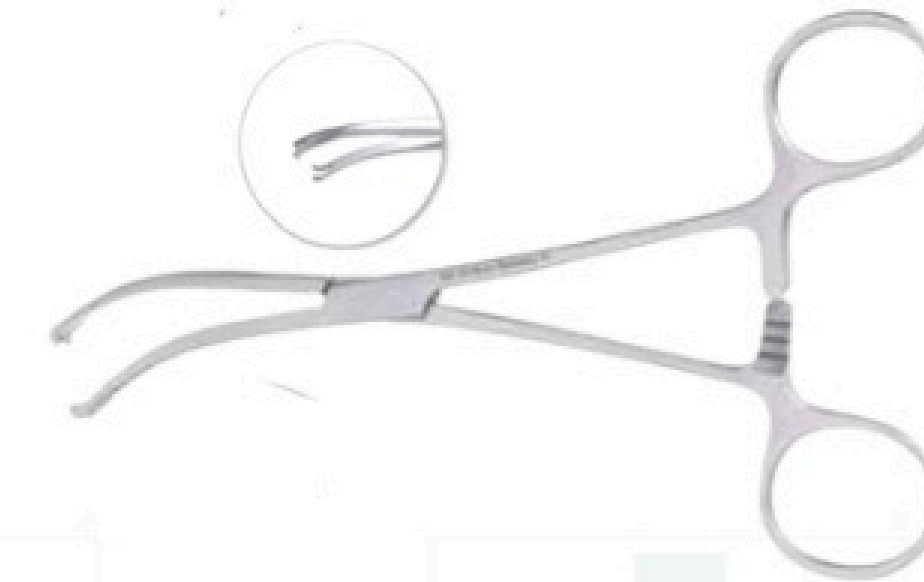

CODE #	DESCRIPTION
ML69795	Slightly curved, 6-1/2" (16.5 cm)

VOGEN SESAMOID CLAMP

- Designed to grasp and hold a sesamoid while dissecting it free.
- The sesamoid is first exposed within the capsule, then the two-pronged tip is hooked beneath the sesamoid. The plunger is then seated in the bone to secure it for manipulation and dissection.



CODE #	DESCRIPTION
ML69827	4" (10 cm) shaft

BONE HOOKS

SHARP HOOK

To check fracture and remove ingrown tissue



CODE #	DESCRIPTION
ML47880	6" (15 cm)

BONE HOOKS

Sharp with grip handle, 9" (23 cm).

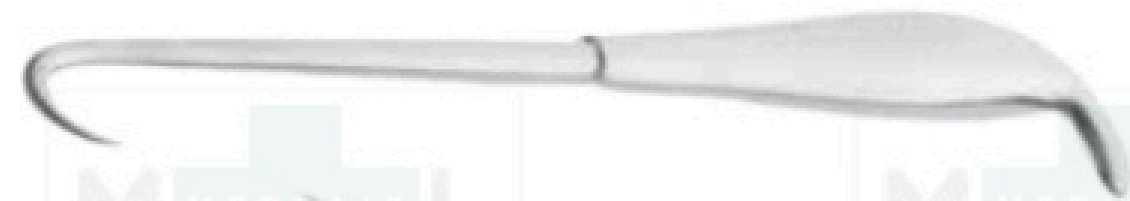

CODE #	DESCRIPTION
ML48342	Small, 6 mm high x 10 mm deep
ML48343	Medium, 11 mm high x 18 mm deep
ML48344	Large, 12 mm high x 21 mm deep

BONE HOOK

Large, for femurs. With T-handle



CODE #	DESCRIPTION
ML48332	18 mm high x 21 mm deep, 7-7/8" (20 cm)

VOLMLANN BONE HOOKS

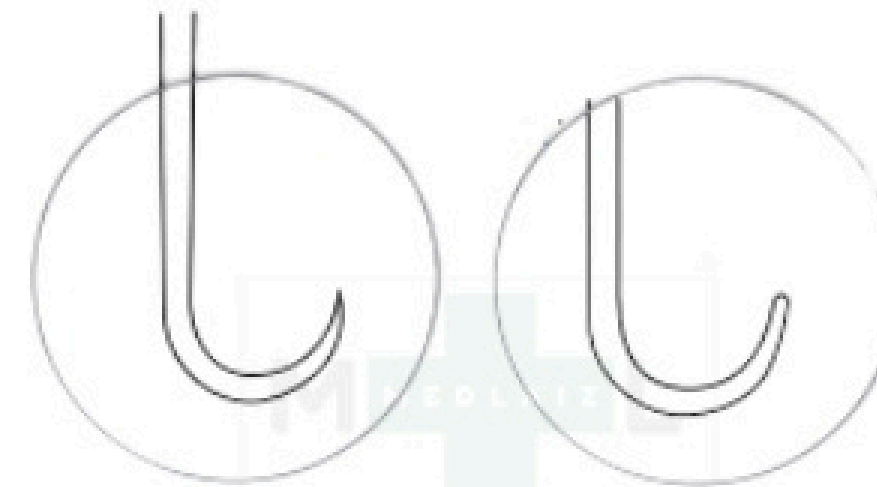

CODE #	DESCRIPTION
ML48331	Sharp, 15 mm high x 20 mm deep, 9" (23 cm)
ML48335	Sharp, 15 mm high x 20 mm deep, 9-3/4" (25 cm)
ML48334	Sharp, 19 mm high x 27 mm deep, 8-5/8" (22 cm)
ML48333	Blunt, 15 mm high x 20 mm deep, 9" (23 cm)

AWLS

BONE AWL



CODE #	DESCRIPTION
ML48336	Square taper, 6-1/4" (16 cm)

SHOULDER PENETRATING AWL

Phenolic handle.



CODE #	DESCRIPTION
ML46916	9-1/4" (23.5 cm)

Autoclavable to 290°F (143°C)

KUNTSCHER DIAMOND POINTED AWL



CODE #	DESCRIPTION
ML48303	With handle, 11-5/8" (29.5 cm)

RUSH AWL AND REAMERS

For penetrating cortex of bone. Used as grooved director for insertion of pins.



CODE #	DESCRIPTION
ML48338	0.1" (2.5 mm) diameter, working length 7-1/2" (19 cm), pointed, 9-7/8" (25 cm)
ML48339	0.1" (3 mm) diameter, working length 8-1/4" (21 cm), pointed, 10-5/8" (27 cm)
ML48340	0.2" (5 mm) diameter, working length 8-1/2" (21.5 cm), pointed, 10-7/8" (27.5 cm)
ML48341	0.25" (6 mm) diameter, working length 10-1/2" (26.5 cm), pointed, 12-3/4" (32.5 cm)

SHOULDER PERCUSSION AWLS

8-1/2" (21.5 cm).

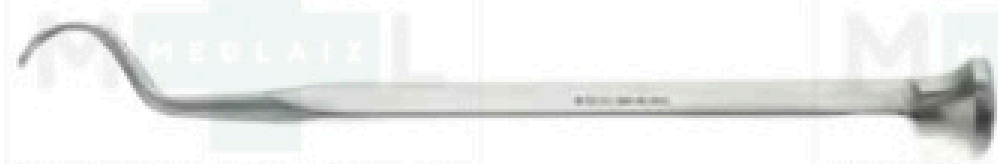

CODE #	DESCRIPTION
ML46913	Small
ML46914	Medium
ML46915	Large



PERTHES BONE AWL



CODE #	DESCRIPTION
ML48337	8-1/4" (21 cm)