

CHISELS AND GOUGES

Chisels and gouges are essential instruments for cutting, shaping, and contouring bone in orthopedic surgery. Chisels provide clean, straight cuts, while gouges are ideal for scooping or carving curved surfaces. Crafted from high-quality surgical steel, our instruments ensure sharpness, durability, and precise control for efficient bone work with minimal tissue disruption.

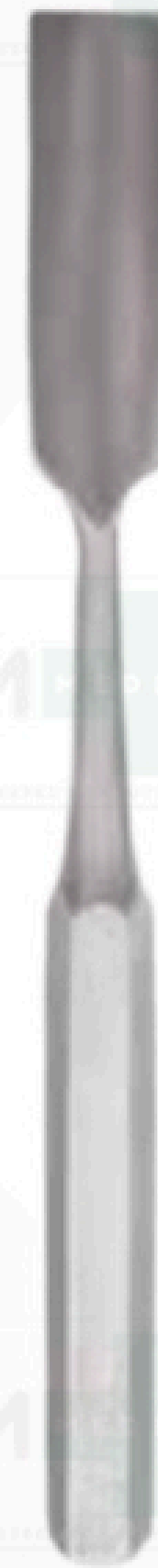
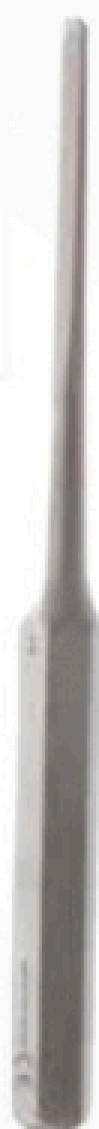
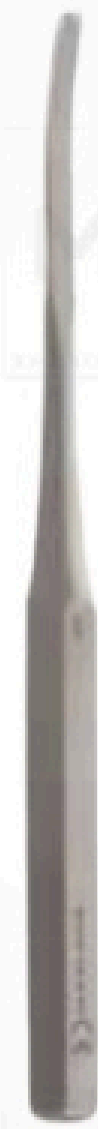
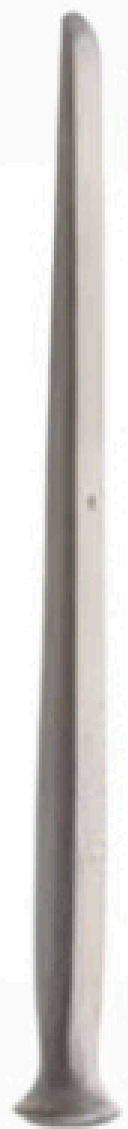

CHISELS

ALEXANDER CHISELS

7-1/8" (18 cm).

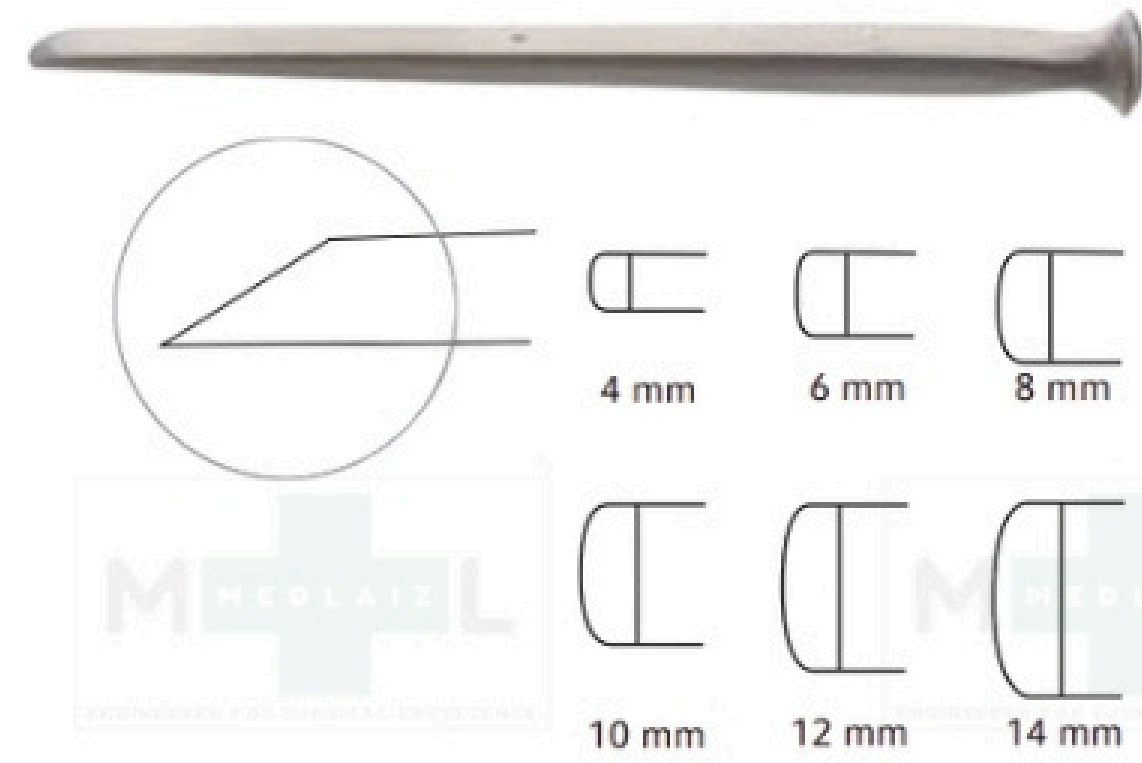

CODE #	DESCRIPTION
ML49040	4 mm
ML49041	6 mm
ML49042	8 mm
ML49043	10 mm
ML49044	12 mm
ML49045	14 mm

HOKE CHISELS

Straight, 5-1/4" (13.5 cm).



CODE #	DESCRIPTION
ML46505	3/16" (4 mm)
ML46506	1/4" (6 mm)
ML46507	3/8" (10 mm)
ML46508	1/2" (13 mm)
ML46509	3/4" (19 mm)

HIBBS CHISELS

9" (23 cm).

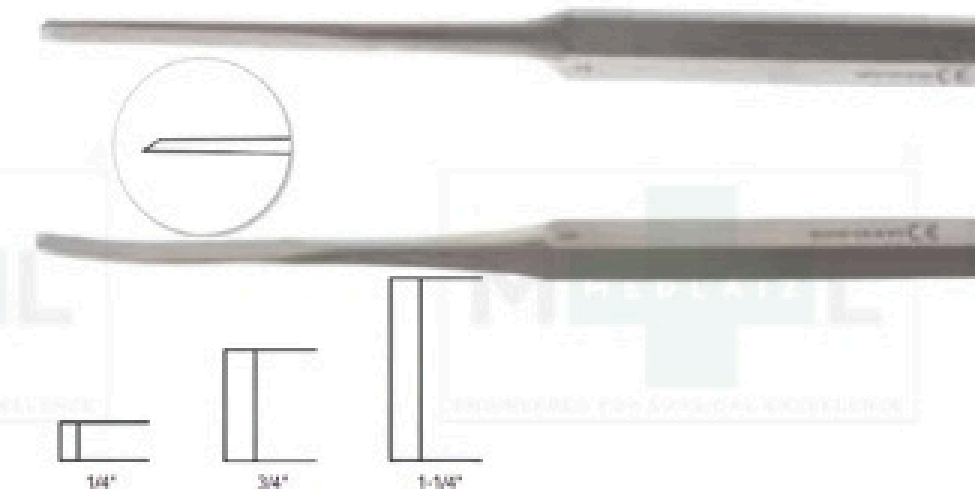

ARMY PATTERN CHISELS

7-1/8" (18 cm).

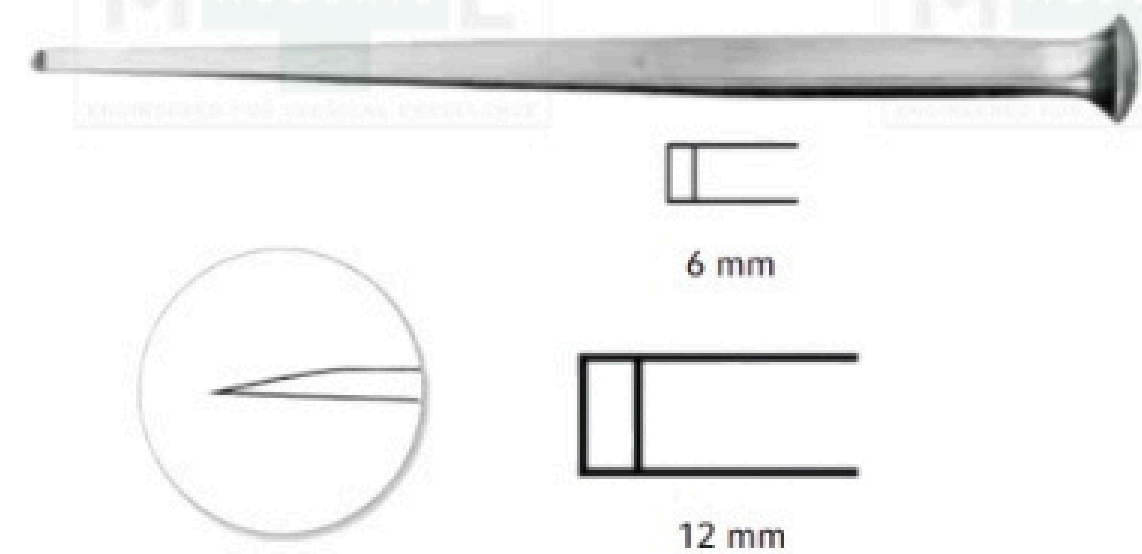

CODE #	DESCRIPTION
ML46289	6 mm
ML46290	12 mm
ML46291	18 mm

CODE #	tip	TIP WIDTH	CODE #	tip	TIP WIDTH
ML49073	Curved	1/4"	ML49059	Straight	1/4"
ML49074	Curved	3/8"	ML49060	Straight	3/8"
ML49075	Curved	1/2"	ML49061	Straight	1/2"
ML49076	Curved	5/8"	ML49062	Straight	5/8"
ML49077	Curved	3/4"	ML49063	Straight	3/4"
ML49078	Curved	1"	ML49064	Straight	1"
ML49081	Curved	1-1/4"	ML49065	Straight	1-1/4"
ML49082	Curved	1-1/2"	ML49066	Straight	1-1/2"

LEXER CHISELS

Phenolic handle, 8-5/8" (22 cm).

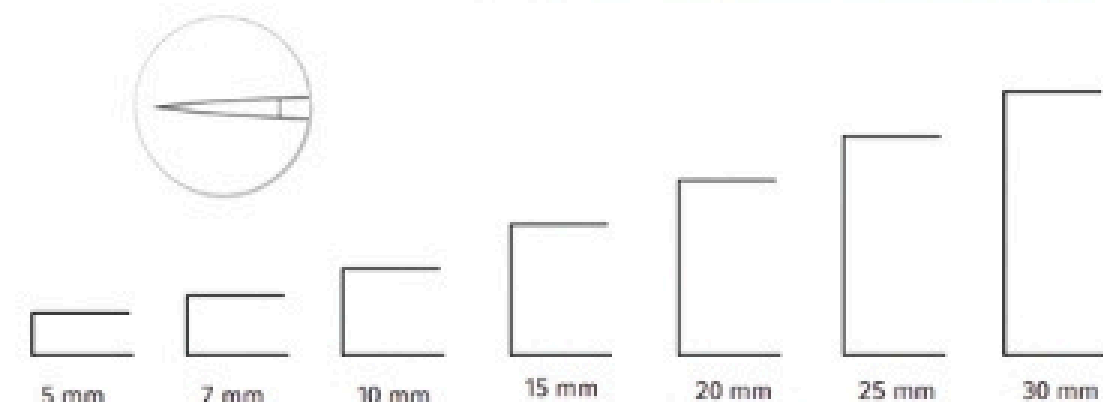

CODE #	DESCRIPTION
ML49246	5 mm
ML49248	7 mm
ML49250	10 mm
ML49252	15 mm
ML49254	20 mm
ML49256	25 mm
ML49258	30 mm

LEXER MINI CHISELS

Phenolic handle, 7-1/8" (18 cm).

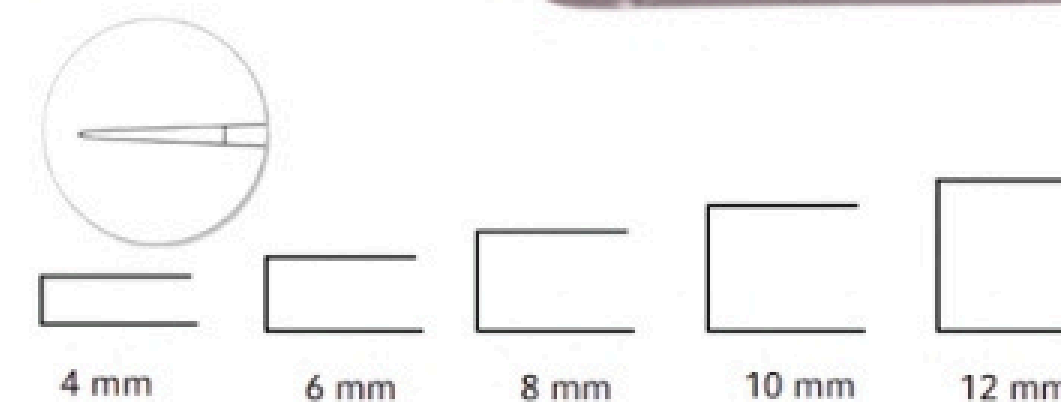

CODE #	DESCRIPTION
ML49260	4 mm
ML49262	6 mm
ML49264	8 mm
ML49266	10 mm
ML49268	12 mm

STILLE-TYPE CHISELS

8-1/8" (20.5 cm)

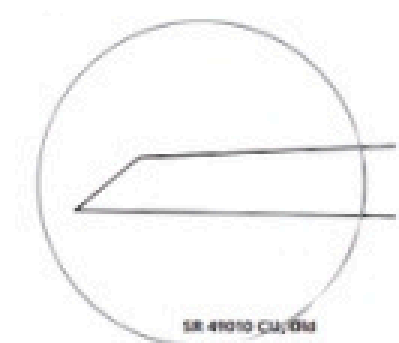

CODE #	DESCRIPTION
ML49010	10 mm
ML49012	14 mm
ML49014	18 mm
ML49016	22 mm

GOUGES

ALEXANDER GOUGES

7" (18 cm).

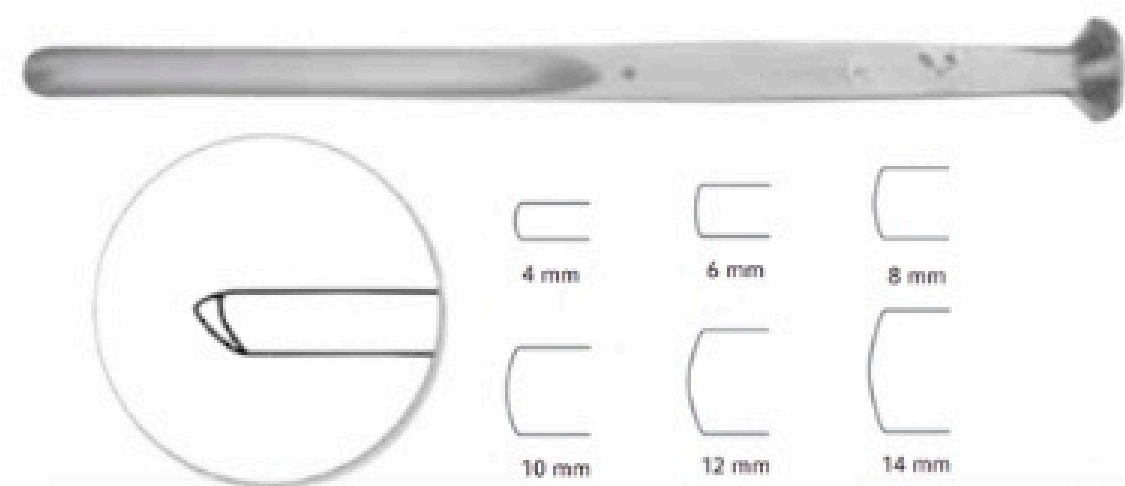

CODE #	DESCRIPTION
ML49050	4 mm
ML49051	6 mm
ML49052	8 mm
ML49053	10 mm
ML49054	12 mm
ML49055	14 mm

STILLE-TYPE GOUGES

8" (20.5 cm).

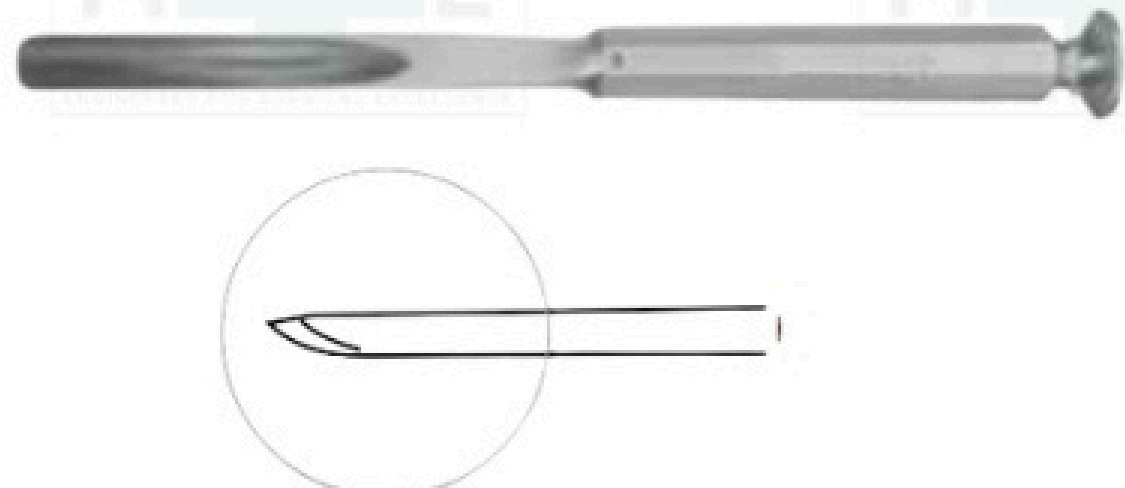

CODE #	DESCRIPTION
ML49018	10 mm
ML49020	14 mm
ML49022	18 mm
ML49024	22 mm

U.S. ARMY PATTERN GOUGES

7" (18 cm).

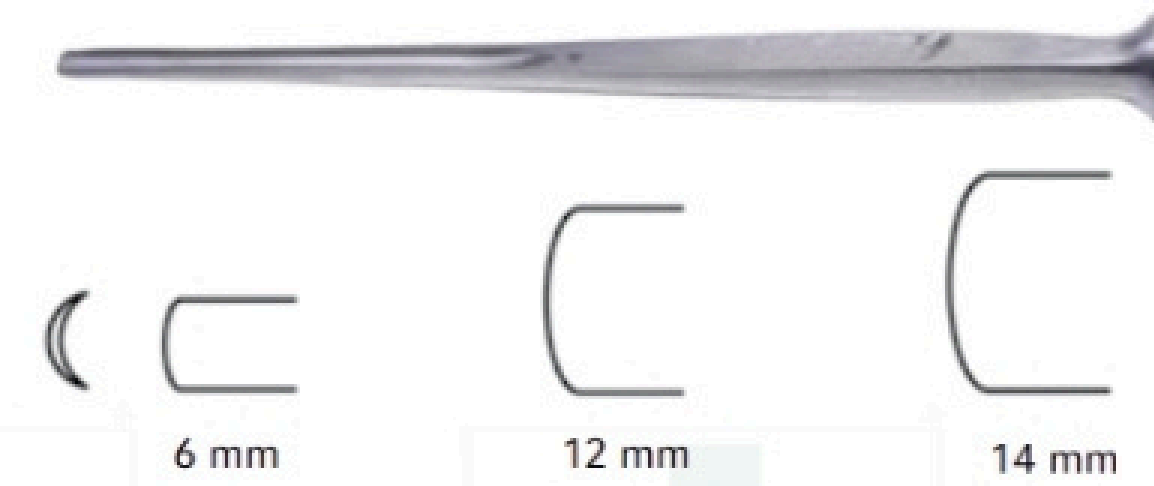

CODE #	DESCRIPTION
ML46292	6 mm
ML46293	12 mm
ML46294	14 mm

SHOULDER PENETRATING GOUGE



CODE #	DESCRIPTION
ML46919	3 mm tip, 8-1/2" (21.5 cm)

SWAN NECK GOUGE



CODE #	DESCRIPTION
ML49084	1" distal tip, 9" (23 cm)

SMITH PETERSON GOUGES

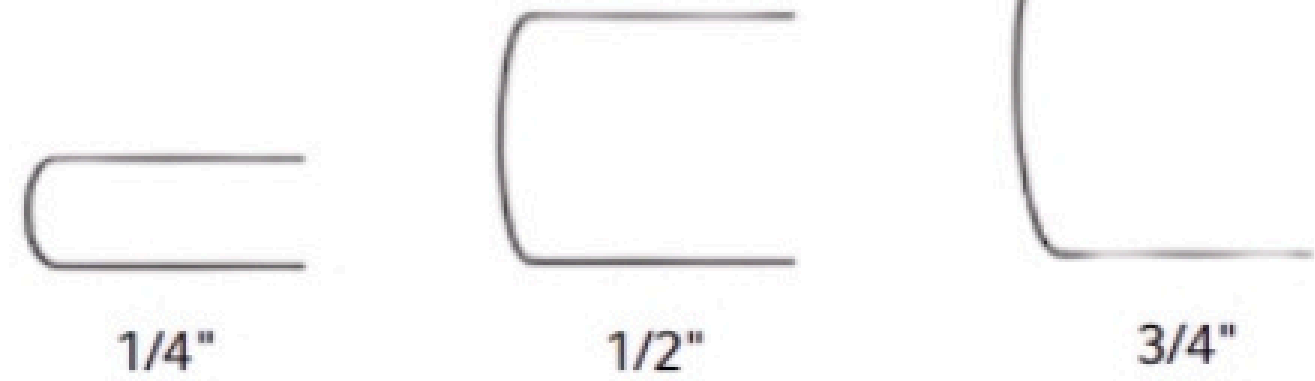
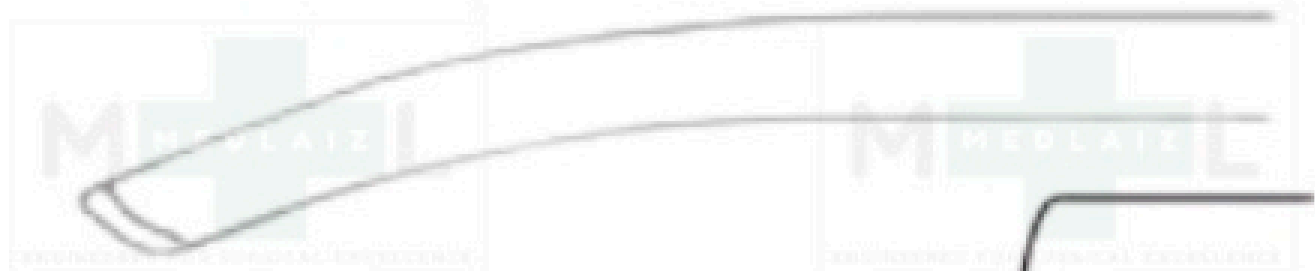
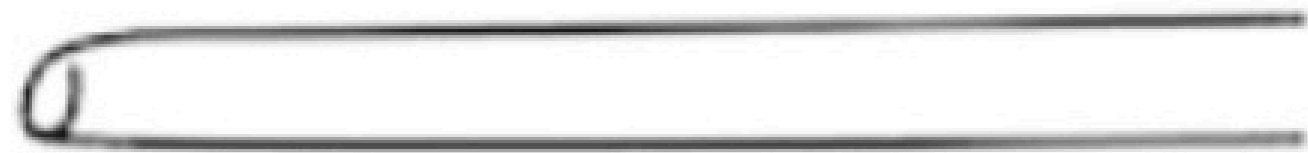

CODE #	tip	TIP WIDTH
KM46466	Straight	1/4"
KM46467	Straight	3/8"
KM46468	Straight	1/2"
KM46476	Straight	5/8"
KM46477	Straight	3/4"
KM46478	Straight	1"
KM46479	Straight	1-1/4"
KM46487	Curved	1/4"
KM46488	Curved	3/8"
KM46489	Curved	1/2"
KM46490	Curved	5/8"
KM46491	Curved	3/4"
KM46493	Curved	1"
KM46495	Curved	1-1/4"

HIBBS GOUGES

9" (23 cm).

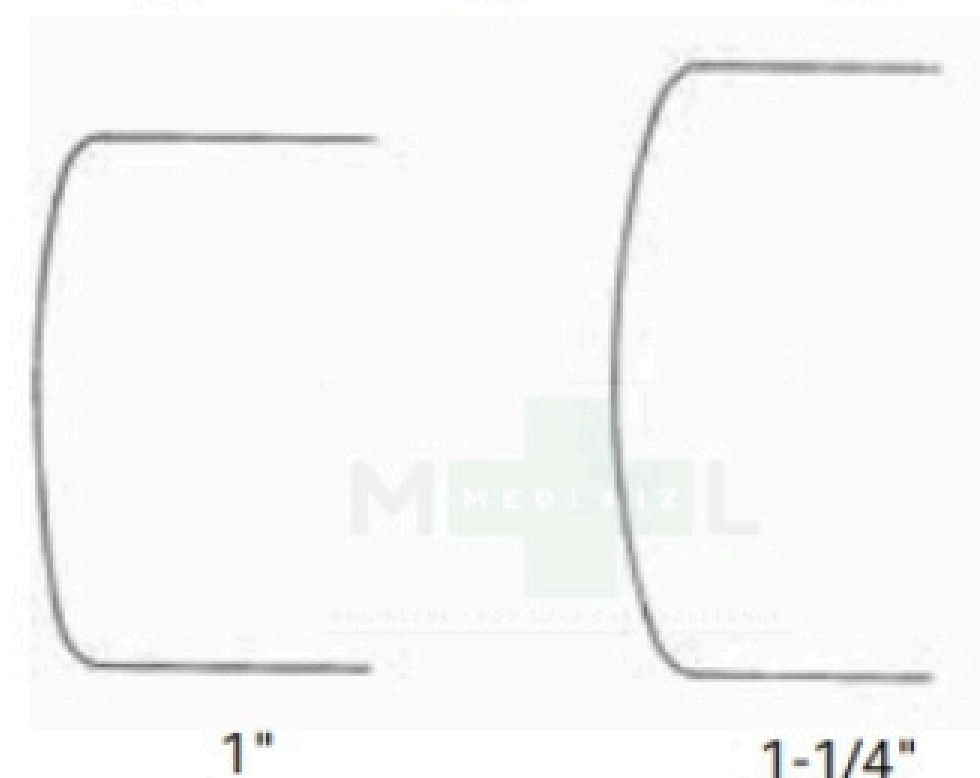
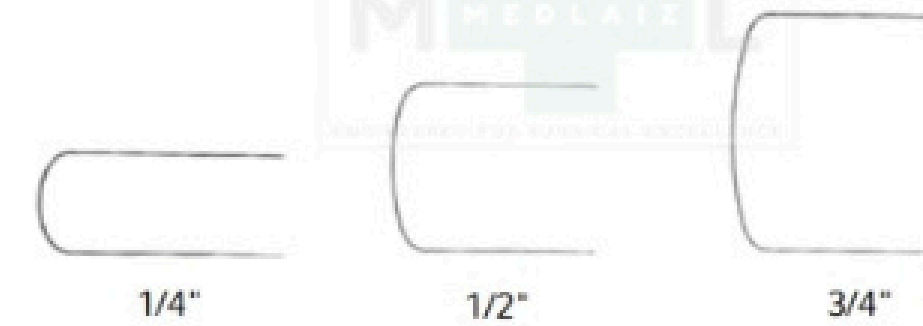
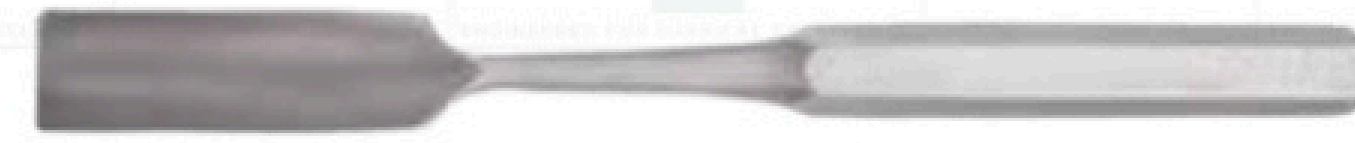

CODE #	tip	TIP WIDTH
KM46387	Straight	1/4"
KM46388	Straight	3/8"
KM46389	Straight	1/2"
KM46390	Straight	5/8"
KM46391	Straight	3/4"
KM46392	Straight	1"
KM46395	Straight	1-1/4"
KM46401	Straight	1-1/2"
KM46402	Curved	1/4"
KM46403	Curved	3/8"
KM46404	Curved	1/2"
KM46405	Curved	5/8"
KM46407	Curved	3/4"
KM46409	Curved	1"
KM46411	Curved	1-1/4"
KM46412	Curved	1-1/2"

HIBBS ENDOSCOPIC GOUGE

Straight tip, stainless steel handle, 18-1/2" (47 cm).

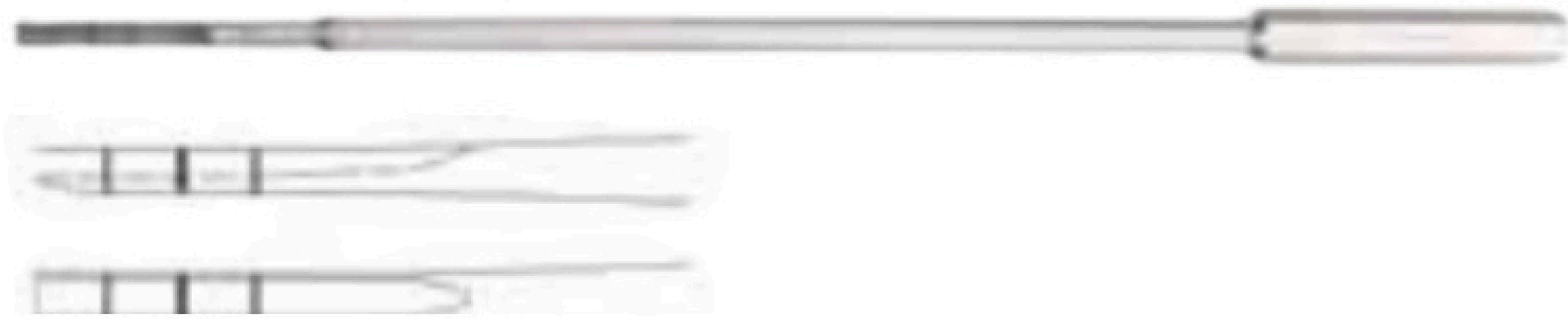

CODE #	TIP WIDTH	TIP LENGTH	SHAFT LENGTH	SHAFT DIAMETER	HANDLE LENGTH
ML55630	0.28" (7 mm)	3-1/2"	10-3/4"	0.43"	4-1/4"

COBB-TYPE SPINAL GOUGES

All stainless, with knurled handle, 5/32" (7 mm) distal tip, 11" (28 cm).

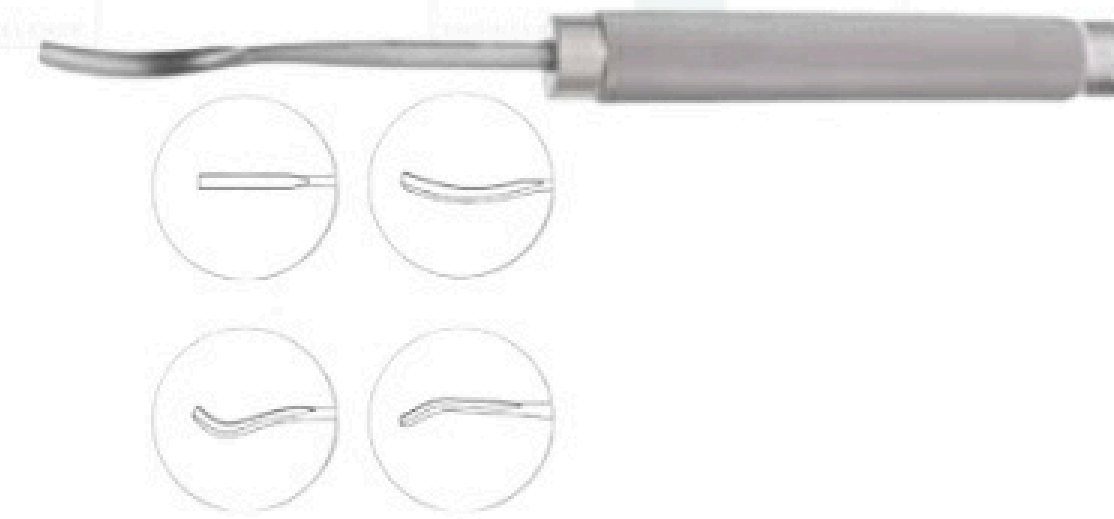

CODE #	DESCRIPTION
ML49030	Straight
ML49032	Medium curve
ML49034	Strong curve
ML49036	Reverse curve