

# ORTHOPEDIC RETRACTORS

Orthopedic retractors are designed to provide clear visibility and access to surgical sites by safely holding back tissue and muscle. Our retractors offer strong yet controlled retraction, minimizing trauma and improving efficiency during procedures. Manufactured from high-grade stainless steel, they are available in a variety of styles to suit different anatomical areas and surgical needs.

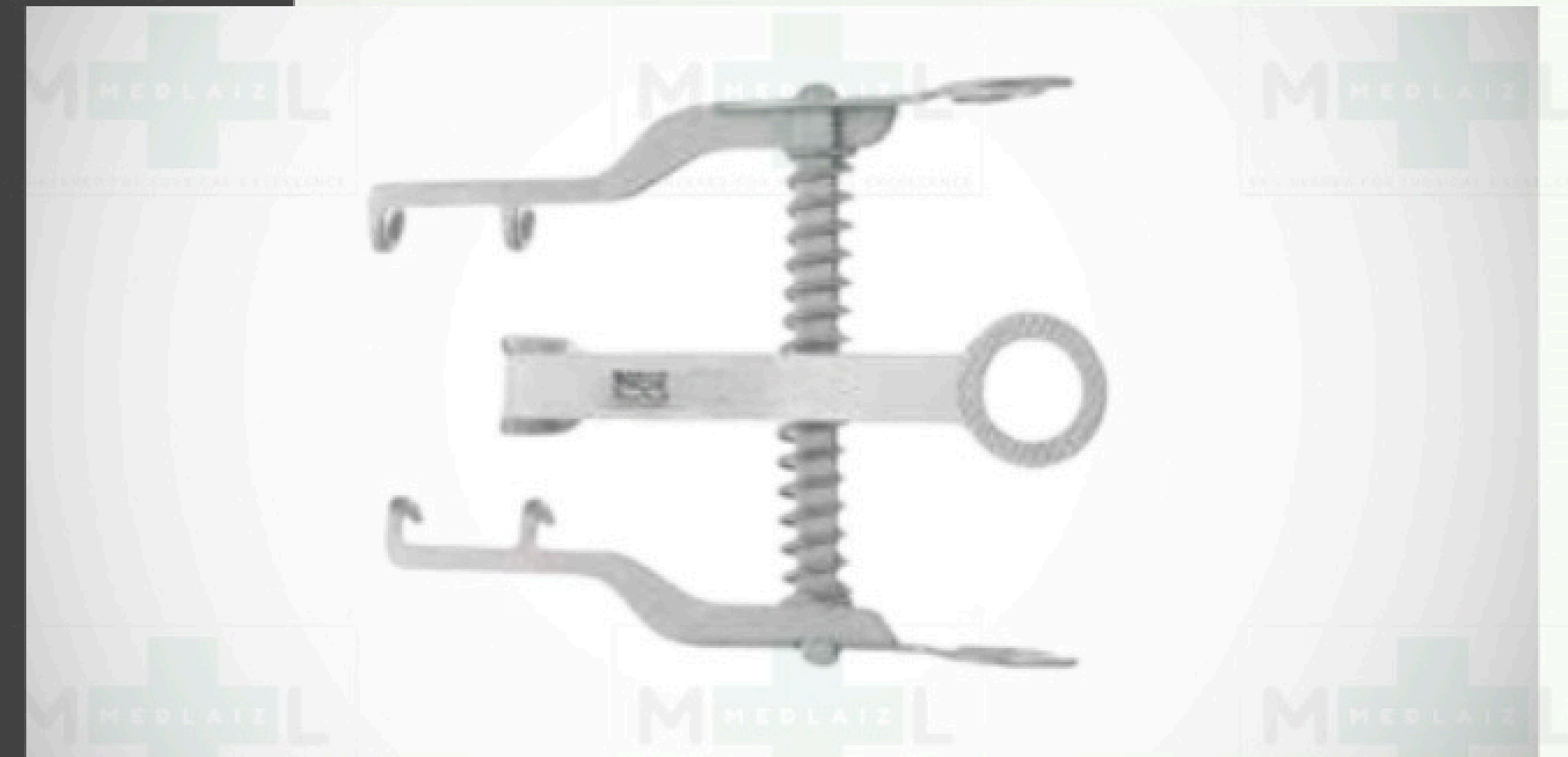

# HAND-HELD ORTHOPEDIC RETRACTORS

## FRAZIER HOOKS

5" (12.5 cm).



| CODE #  | DESCRIPTION                    |
|---------|--------------------------------|
| ML48158 | 1 sharp prong, 2.5 mm diameter |
| ML48161 | 1 blunt prong, 2.5 mm diameter |

## ADSON DISSECTOR HOOKS

8" (20.5 cm).



| CODE # | DESCRIPTION |
|--------|-------------|
| 654180 | Blunt       |
| 654181 | Sharp       |

## GILLIES HOOKS

7" (18 cm).



| CODE #  | DESCRIPTION |
|---------|-------------|
| ML58077 | Small       |
| ML58083 | Large       |

## FRAZIER DURA HOOKS



| CODE # | DESCRIPTION             |
|--------|-------------------------|
| 654190 | Blunt, 4-3/4" (12 cm)   |
| 654191 | Sharp, 4-7/8" (12.5 cm) |

## HOEN HOOKS



| CODE # | DESCRIPTION |
|--------|-------------|
| 594400 | Short prong |
| 594402 | Long prong  |

## SMITHWICK DISSECTOR AND HOOK

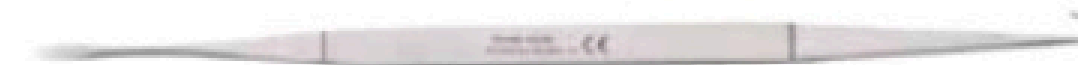

| CODE # | DESCRIPTION     |
|--------|-----------------|
| 622700 | 12-1/4" (31 cm) |

## SNOOK HOOK

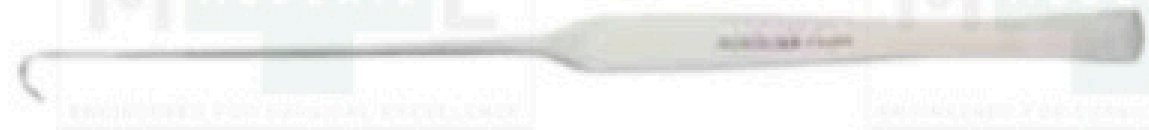

| CODE #  | DESCRIPTION  |
|---------|--------------|
| ML71431 | 8" (20.5 cm) |

## HOLSHER NERVE RETRACTORS

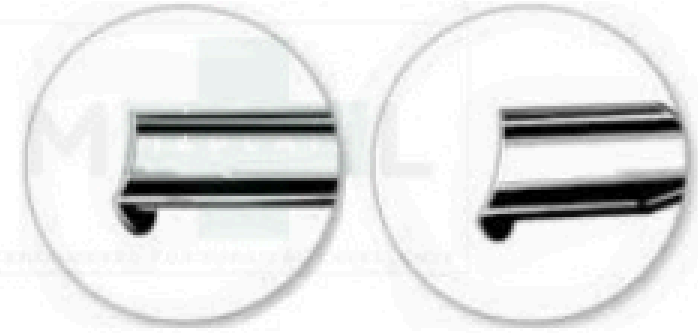

| CODE #  | DESCRIPTION |
|---------|-------------|
| ML48234 | 7 mm blade  |
| ML48237 | 9 mm blade  |

## NERVE ROOT RETRACTOR

Retractor blade lies on same plane as surgeon's finger. Gives surgeon unobstructed view

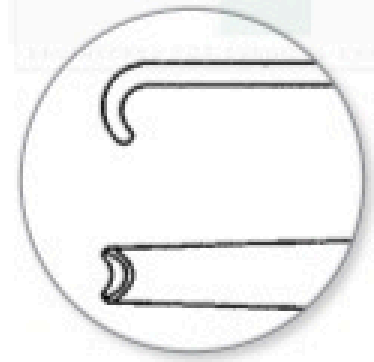

| CODE #  | DESCRIPTION                |
|---------|----------------------------|
| ML55424 | 6 mm blade, 8-1/4" (21 cm) |

## SCOVILLE NERVE ROOT RETRACTORS

Angled.



| CODE #  | DESCRIPTION                   |
|---------|-------------------------------|
| ML55426 | 8 mm blade, 8" (20.5 cm)      |
| ML55428 | 13 mm blade, 7-5/8" (19.5 cm) |

## RAGNELL-LINDE RETRACTOR

Fine cross serrations help prevent slippage. Double-ended with serrations, 5-1/4" (13.5 cm).

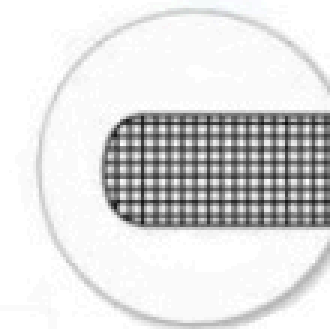
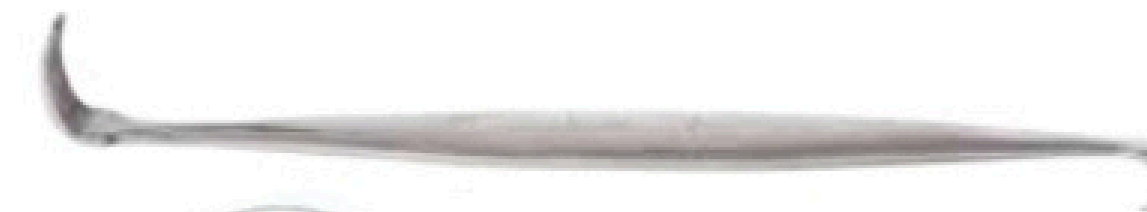

| CODE #  | DESCRIPTION                   |
|---------|-------------------------------|
| ML69982 | 4 x 8 mm and 6 x 15 mm blades |

## BAYONET NERVE RETRACTOR

| CODE #  | DESCRIPTION                 |
|---------|-----------------------------|
| ML69982 | 7 mm wide x 1 mm deep blade |

## PERPENDICULAR NERVE RETRACTOR

| CODE #  | DESCRIPTION                                   |
|---------|---|
| ML69982 | 7 mm wide x 1 mm deep blade angled 90 degrees |

## BLADE RETRACTORS



| CODE #  | DESCRIPTION                  |
|---------|------------------------------|
| ML55420 | 18 mm wide blade, 7" (18 cm) |
| ML55421 | 20 mm wide blade, 7" (18 cm) |
| ML55422 | 23 mm wide blade, 7" (18 cm) |

## LANGENBECK RETRACTORS

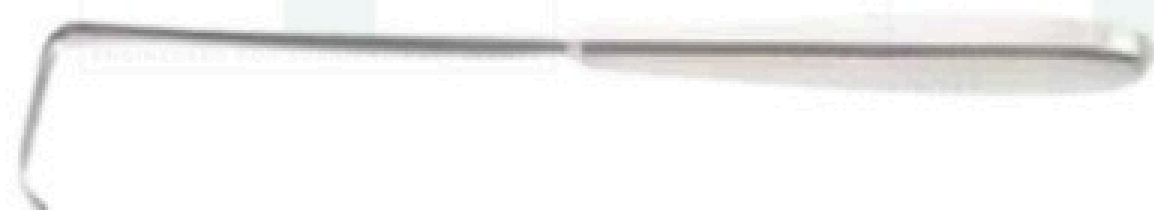

| CODE #  | DESCRIPTION                                      |
|---------|--|
| ML51100 | #1, 3/8" x 1-1/4" (10 x 32 mm), 8-7/8" (22.5 cm) |
| ML51104 | #2, 3/8" x 1-3/4" (10 x 45 mm), 8" (20.5 cm)     |
| ML51108 | #3, 1/2" x 1-3/4" (15 x 45 mm), 8-1/2" (21.5 cm) |
| ML51112 | #4, 5/8" x 1-1/2" (16 x 38 mm), 8" (20.5 cm)     |

## OLLIER RAKE RETRACTOR



| CODE #  | DESCRIPTION   |
|---------|---|
| ML52282 | 4 blunt prongs, 55 mm wide x 40 mm deep blade, 9" (23 cm) |

## DEEP RAKE RETRACTORS

10-1/2" (26.5 cm).



| CODE #  | DESCRIPTION  |
|---------|--|
| ML52292 | 4 blunt prongs, 2-1/4" wide x 1-1/2" deep (5.5 x 4 cm)   |
| ML52294 | 4 blunt prongs, 2-1/4" wide x 2" deep (5.5 x 5 cm)       |
| ML52296 | 4 blunt prongs, 2-1/4" wide x 2-1/2" deep (5.5 x 6.5 cm) |
| ML52298 | 4 blunt prongs, 2-1/4" wide x 3" deep (5.5 x 7.5 cm)     |

## MEYERDING LAMINECTOMY RETRACTORS

Sharp teeth.

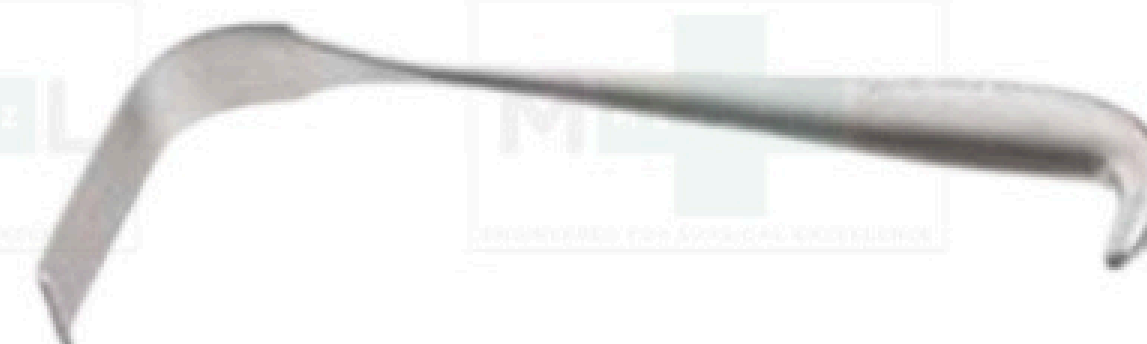

| CODE #  | DESCRIPTION                              |
|---------|--|
| ML51158 | Small, 17 mm wide blade, 9-1/2" (24 cm)  |
| ML51162 | Medium, 25 mm wide blade, 9-1/2" (24 cm) |
| ML51164 | Large, 50 mm wide blade, 10" (25.5 cm)   |

## ISRAEL RAKE RETRACTORS

9-1/2" (24 cm)



| CODE #  | DESCRIPTION                             |
|---------|---|
| ML51078 | 3 blunt prongs, 30 mm wide x 37 mm deep |
| ML51080 | 4 blunt prongs, 40 mm wide x 40 mm deep |

## HIBBS RETRACTORS

Used for deep soft tissue retraction. Sharp teeth, 9-1/2" (24 cm)

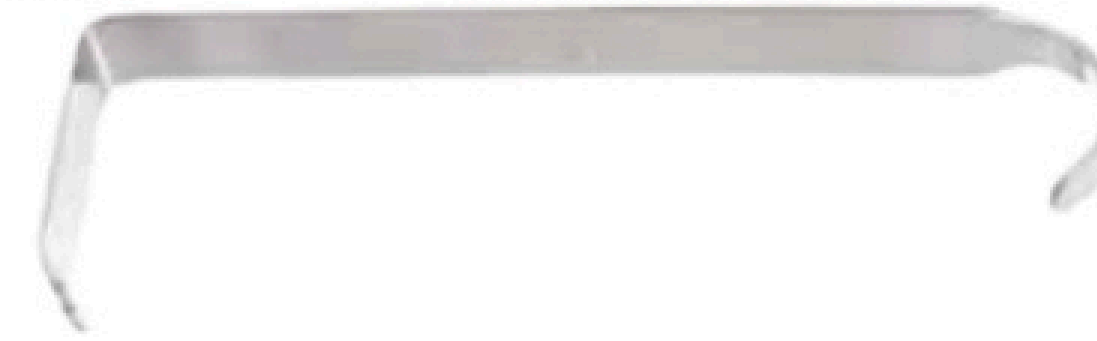

| CODE #  | DESCRIPTION                    |
|---------|--------------------------------|
| ML51059 | 25 mm wide x 50 mm deep blade  |
| ML51060 | 26 mm wide x 75 mm deep blade  |
| ML51061 | 25 mm wide x 100 mm deep blade |

## TAYLOR SPINAL RETRACTORS



| CODE #  | DESCRIPTION  |
|---------|--|
| ML52458 | 1-1/4" wide x 3" long blade (3 x 7.5 cm), 7-3/4" (19.5 cm) |
| ML52460 | 1-1/4" wide x 4" long blade (3 x 10 cm), 7-3/4" (19.5 cm)  |

## AUFRANC COBRA RETRACTORS

With hollow handle, 1-1/4" wide blade, 10-1/2" (26.5 cm)

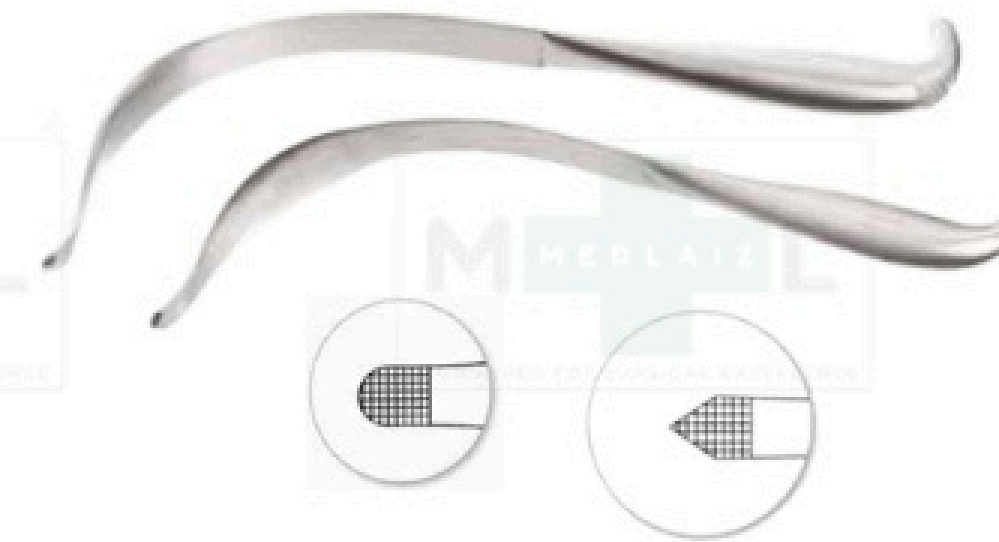

| CODE #  | DESCRIPTION                  |
|---------|------------------------------|
| ML48208 | Serrated, pointed tip, 10 mm |
| ML48212 | Smooth, blunt tip, 10 mm     |
| ML48210 | Serrated, blunt tip, 10 mm   |
| ML48214 | Smooth, pointed tip, 10 mm   |

## TAYLOR RETRACTORS

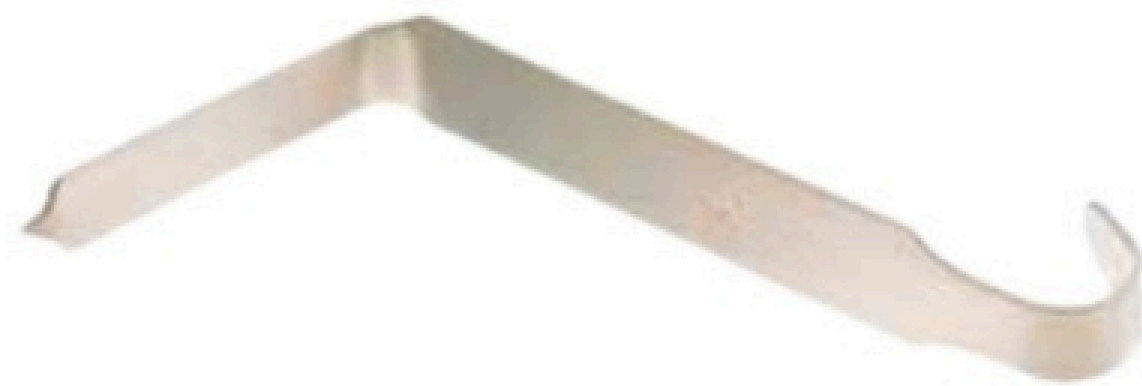

| CODE #  | DESCRIPTION   |
|---------|---|
| ML46934 | Distal tip 3/4" wide and 3" long (20 x 76 mm), overall length 8-1/8" (20.5 cm)  |
| ML46936 | Distal tip 3/4" wide and 4" long (20 x 102 mm), overall length 8-1/8" (20.5 cm) |

# BENNETT BONE ELEVATOR AND RETRACTORS

Hollow handle, 10" (25.5 cm).



| CODE #  | DESCRIPTION                       |
|---------|-----------------------------------|
| ML46880 | Small, 1-3/4" (4.5 cm) wide blade |
| ML46884 | Large, 2-1/2" wide blade          |

# MURPHY BONE SKID



| CODE #  | DESCRIPTION     |
|---------|-----------------|
| ML46892 | 11-3/4" (30 cm) |

# PELVIC RETRACTOR

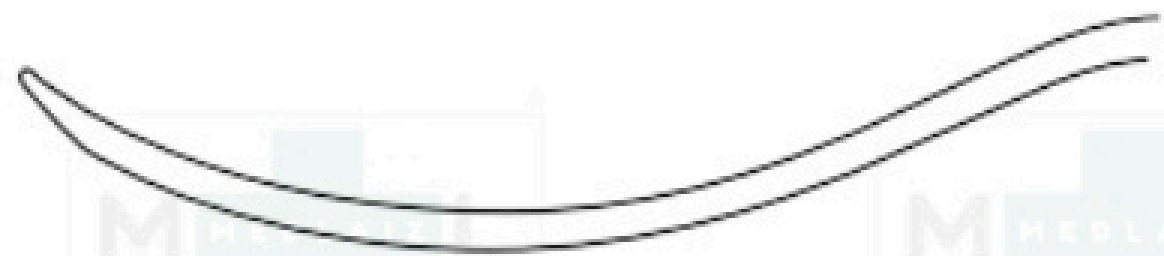

| CODE #  | DESCRIPTION  |
|---------|--|
| ML48201 | 1" (24 mm) wide blade, 1/2" (12 mm) wide distal tip, 10-5/8" (27 cm) |

# SHOULDER & KNEE RETRACTORS

## FUKUDA STYLE SHOULDER RETRACTORS

7" (18 cm).



| CODE #  | DESCRIPTION                                   |
|---------|---|
| ML46906 | 1-1/2" wide x 3-1/4" long blade<br>(4 x 8 cm) |
| ML46907 | 1-1/4" wide x 3-1/4" long blade<br>(3 x 8 cm) |

## BRISTOW/BANKART HUMERAL RETRACTOR



| CODE #  | DESCRIPTION   |
|---------|---|
| ML46870 | 2 blunt prongs, 25 mm wide x<br>102 mm deep, 7-1/2" (19 cm) |

## BRISTOW/BANKART SOFT TISSUE RETRACTOR



| CODE #    | DESCRIPTION   |
|-----------|---|
| ML46872 3 | 3 blunt prongs, 21 mm wide<br>blade, 7-7/8" (20 cm) |

## HUMERAL HEAD RETRACTOR



| CODE #  | DESCRIPTION                         |
|---------|-------------------------------------|
| ML46860 | 18 mm wide blade, 8-3/4" (22<br>cm) |

## CAPSULE RETRACTOR



| CODE #  | DESCRIPTION   |
|---------|---|
| ML46908 | 3 blunt prongs, 21 mm wide<br>blade, 7-7/8" (20 cm) |

## BLOUNT DOUBLE PRONG RETRACTOR



| CODE #  | DESCRIPTION                                      |
|---------|--|
| ML48204 | 1-3/4" (44 mm) wide blade, 10-<br>1/2" (26.5 cm) |

## BLOUNT KNEE RETRACTOR



| CODE #  | DESCRIPTION                            |
|---------|--|
| ML48206 | 6 mm wide distal tip, 6-7/8" (17.5 cm) |

## BLOUNT SINGLE PRONG RETRACTOR



| CODE #  | DESCRIPTION                                   |
|---------|---|
| ML48202 | 1-1/2" (37 mm) width blade, 10-1/2" (26.5 cm) |

## SMILLIE KNEE RETRACTORS

5-1/2" (14 cm).



| CODE #  | DESCRIPTION                                  |
|---------|--|
| ML48192 | Reverse curve, 13 mm wide x 55 mm long blade |
| ML48198 | 19 mm wide x 30 mm long blade                |
| ML48194 | 19 mm wide x 45 mm long blade                |
| ML48196 | 19 mm wide x 60 mm long blade                |
| ML48200 | Full curve, 13 mm wide x 18 mm long blade    |

# HOHMANN RETRACTORS

## HAYES HAND RETRACTORS

Used to elevate carpals and phalanges during hand procedures.

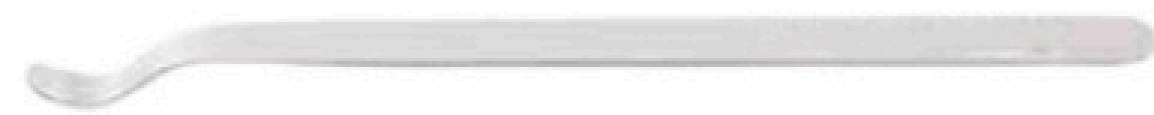

| CODE #  | DESCRIPTION                          |
|---------|--------------------------------------|
| ML46823 | 3 mm wide distal tip, 6-1/4" (16 cm) |
| ML46829 | 6 mm wide distal tip, 6" (15 cm)     |

## HOHMANN RETRACTORS



| CODE #  | DESCRIPTION                                |
|---------|--|
| ML46858 | 8 mm wide blade, 8-1/2" (21.5 cm)          |
| ML46836 | 10 mm wide blade, 9" (23 cm)               |
| ML46838 | 18 mm wide blade, 9" (23 cm)               |
| ML46848 | 22 mm wide blade, three holes, 11" (28 cm) |

## MINI HOHMANN RETRACTORS

6-1/2" (16.5 cm).

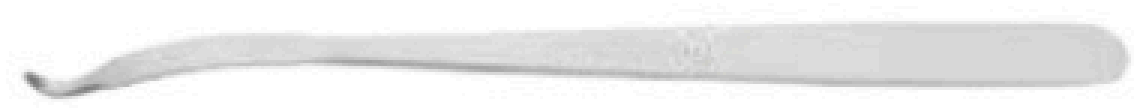

| CODE #  | DESCRIPTION     |
|---------|-----------------|
| ML46830 | 6 mm wide blade |
| ML46832 | 8 mm wide blade |

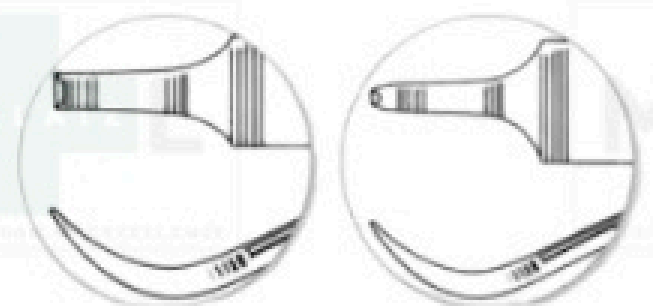

## HOHMANN RETRACTORS



| CODE #  | DESCRIPTION                                    |
|---------|--|
| ML46842 | 43 mm wide blade, 9-1/2" (24 cm)               |
| ML46841 | 43 mm wide blade, long 64 mm shank, 9" (23 cm) |
| ML46850 | 70 mm wide blade, 9-1/2" (24 cm)               |

## HOHMANN RETRACTORS

For small fragments

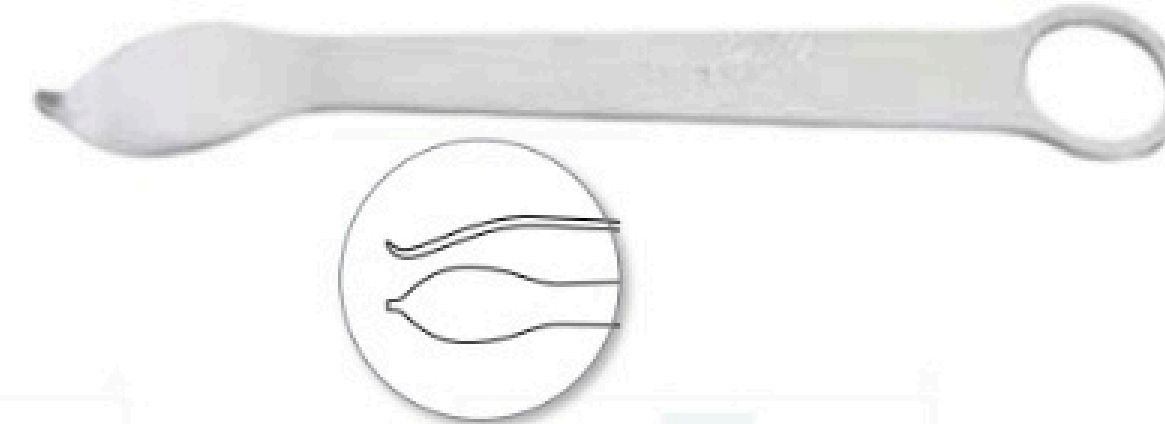

| CODE #  | DESCRIPTION   |
|---------|---|
| ML46826 | Finger ring handle, broad tip, 16 mm wide blade, 4-3/4" (12 cm) |

## HOHMANN RETRACTORS

Useful in exposing acetabulum



| CODE #  | DESCRIPTION   |
|---------|---|
| ML46849 | 35 mm wide blade with wide tip, long 52 mm shank, 11-1/4" (28.5 cm) |
| ML46852 | 22 mm wide blade curved 120 degrees, 16" (40.5 cm)                  |
| ML46854 | 40 mm wide blade curved 90 degrees, 13" (33 cm)                     |

## HOHMANN RETRACTORS

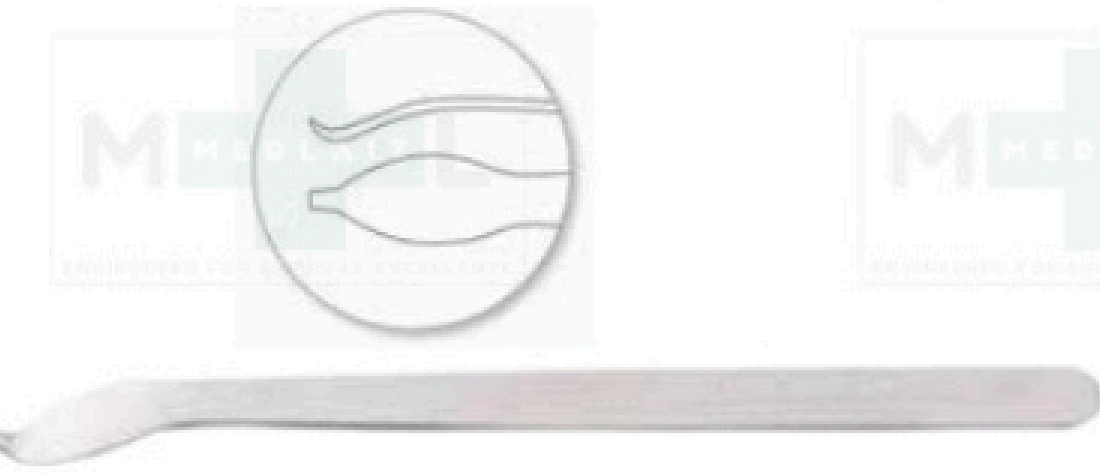

| CODE #  | DESCRIPTION                             |
|---------|---|
| ML46827 | Broad tip, 15 mm wide blade, 6" (15 cm) |

## VICKERS FINGER RETRACTOR

The new Vickers Retractors are designed to provide excellent visibility during hand and wrist procedures. Each of the retractors is self-retaining and automatically expands the wound site. Ideal for retracting wounds on either the front, back or sides of fingers or thumb



| CODE #  | DESCRIPTION  |
|---------|--|
| ML52425 | VICKERS FINGER RETRACTOR ML52425 2" x 3/4" x 1-1/4" (51 mm x 19 mm x 32 mm) 2 x 2 blunt hooks Maximum opening: 19 mm |

## VICKERS LOW PROFILE HAND RETRACTOR

With three blunt prongs to secure placement

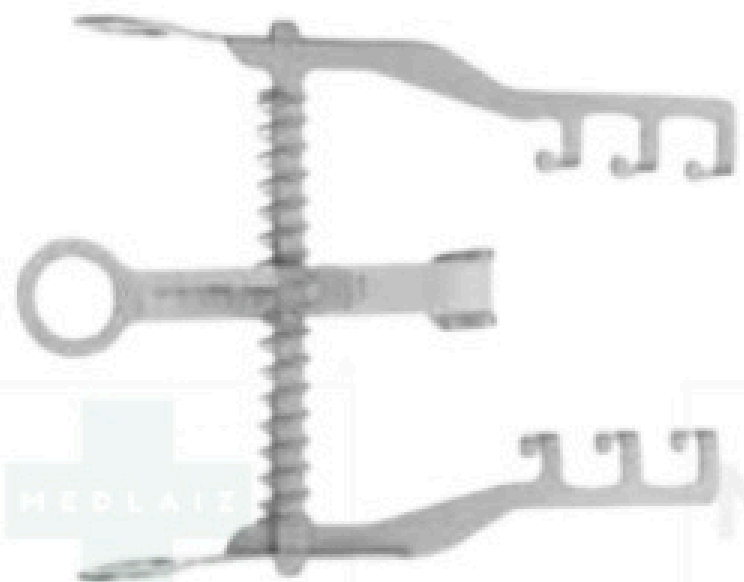

| CODE #  | DESCRIPTION                   |
|---------|-------------------------------|
| ML52427 | 3 x 3 prongs, 3-1/4" (8.5 cm) |

## SELF-RETAINING ORTHOPEDIC RETRACTORS

### VICKERS LOW PROFILE SMALL WOUND RETRACTOR

Useful for small wound retraction.



| CODE #  | DESCRIPTION   |
|---------|---|
| ML52426 | 10 mm deep x 12 mm high, curved, smooth blades, maximum opening 30 mm, center blade 10 mm x 16 mm, 2-1/2" x 3" (6.5 x 7.5 cm) |

### VICKERS UNIVERSAL RETRACTOR

With two blunt prongs to secure placement

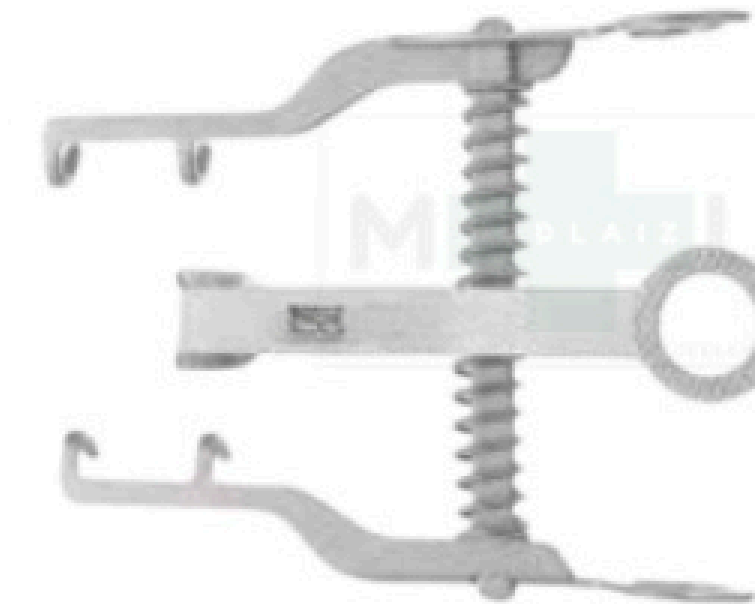

| CODE #  | DESCRIPTION   |
|---------|---|
| ML52428 | 2 x 2 blunt prongs, 8 mm deep x 17 mm high, maximum opening 30 mm, center blade 10 mm x 16 mm, 2-1/2" x 3" (64 x 75 mm) |

## COX METATARSAL SPREADER

- Specially designed thin serrated blades fit anatomically correct against the metatarsals.
- Precise design assures slip-proof hold on metatarsals.
- Affords excellent visibility for the surgeon.
- Designed by Dr. Kenneth Cox

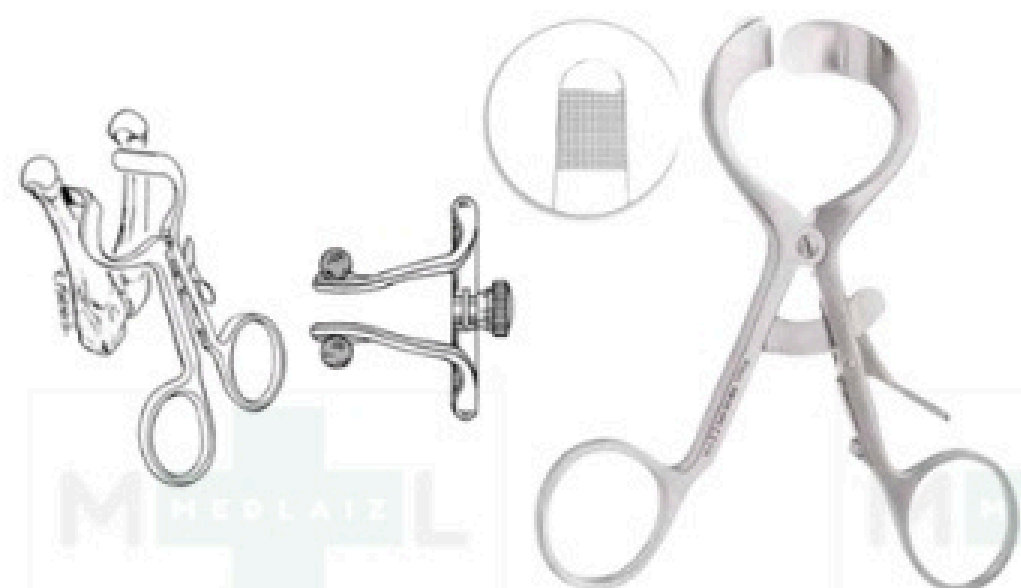

| CODE #  | DESCRIPTION                         |
|---------|-------------------------------------|
| ML69990 | 11 mm wide blades, 4-1/2" (11.5 cm) |

## TISSUE RETRACTOR



| CODE #  | DESCRIPTION                                      |
|---------|--|
| ML55438 | 1 x 1 blunt prongs, 13 mm deep, 5-1/4" (13.5 cm) |

## KOLBEL SOFT TISSUE RETRACTOR



| CODE #  | DESCRIPTION                       |
|---------|-----------------------------------|
| ML46922 | Angled, 2 x 2-pronged, 7" (18 cm) |

## SNITMAN ENDAURAL RETRACTOR



| CODE #  | DESCRIPTION        |
|---------|--------------------|
| ML55497 | 3 x 3 sharp prongs |

## D'ERRICO-ADSON RETRACTOR

Angular prongs are heavier than those on a standard Adson.



| CODE #  | DESCRIPTION  |
|---------|--|
| ML55498 | 4 x 4 sharp prongs, 3/4" (2 cm) deep blade, 7-3/8" (19 cm) |

## MALTZ-SEEBURGER RETRACTORS



| CODE #  | DESCRIPTION      |
|---------|------------------|
| ML58240 | 4-1/2" (11.5 cm) |
| ML58242 | 5-1/2" (14 cm)   |

## SCALP CONTOUR RETRACTORS

Useful in hand procedures because handle is non-obstructive.



| CODE #  | DESCRIPTION                        |
|---------|------------------------------------|
| ML52546 | 3 x 4 blunt prongs, 5-1/2" (14 cm) |
| ML52548 | 3 x 4 sharp prongs, 5-1/2" (14 cm) |

## MARKHAM-MEYERDING HEMILAMINECTOMY RETRACTORS



| CODE #  | DESCRIPTION   |
|---------|---|
| ML55440 | Left sharp blade 60 mm deep x 25 mm wide, 7" (18 cm)  |
| ML55441 | Right sharp blade 60 mm deep x 25 mm wide, 7" (18 cm) |

## MEYERDING LAMINECTOMY RETRACTORS

Sharp blades, 6-1/2" (16.5 cm).



| CODE #  | DESCRIPTION                    |
|---------|--------------------------------|
| ML55430 | Blades 57 mm deep x 25 mm wide |
| ML55431 | Blades 51 mm deep x 25 mm wide |
| ML55432 | Blades 41 mm deep x 25 mm wide |

## WILTSE-GELPI RETRACTOR

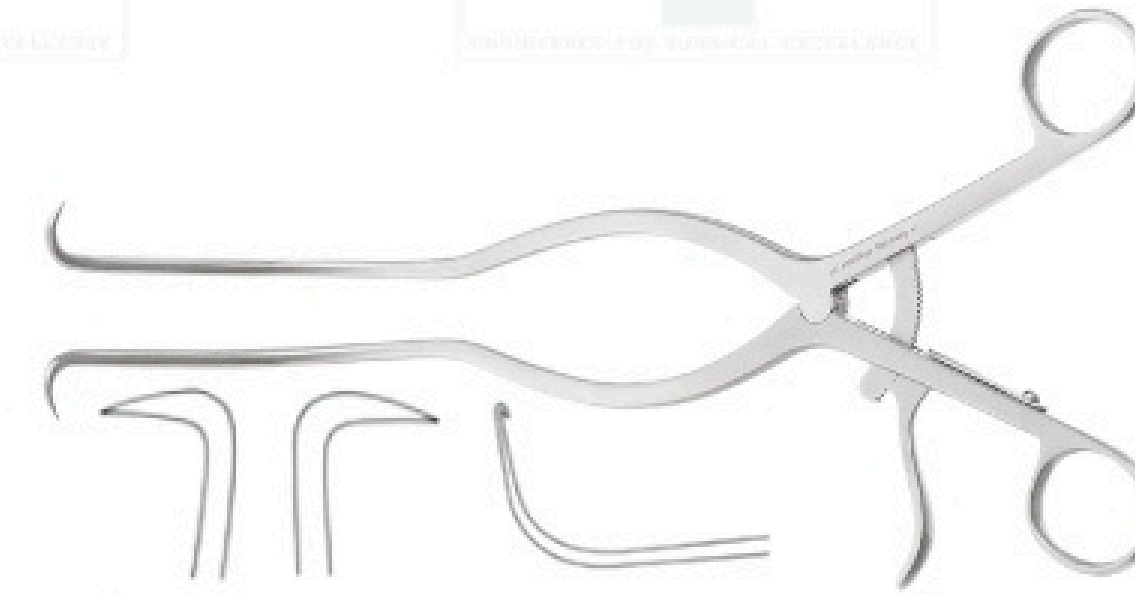

| CODE #  | DESCRIPTION                                  |
|---------|--|
| ML52771 | Deep blades, sharp points, 10-7/8" (27.5 cm) |

## GELPI-SELETZ RETRACTOR



| CODE #  | DESCRIPTION                               |
|---------|---|
| ML52765 | Sharp points, deep blades, 6-1/4" (16 cm) |

## BECMLAN RETRACTOR

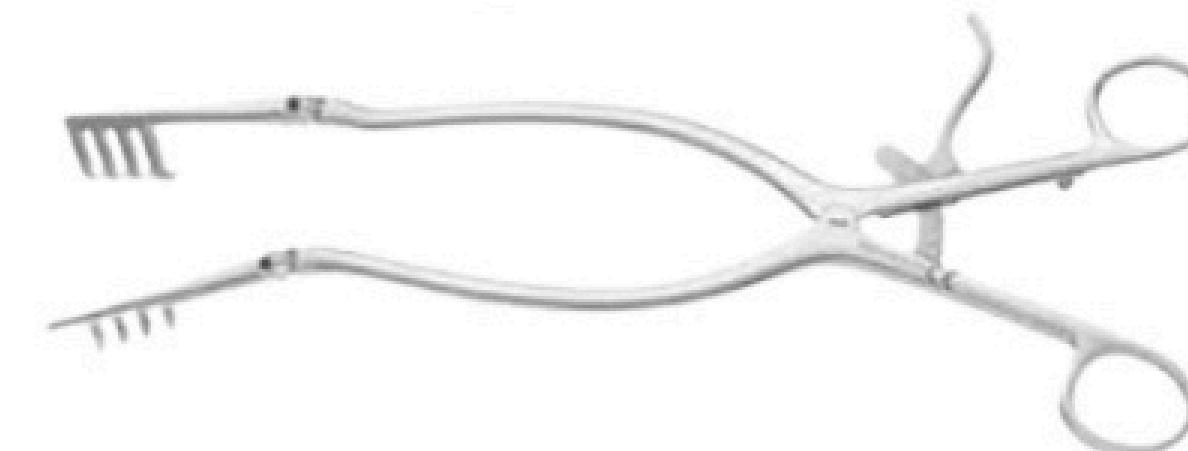

| CODE #  | DESCRIPTION   |
|---------|---|
| ML52470 | 4 x 4 sharp prongs, 27 mm, side blade 5/8" (1.5 cm) deep, 12-1/4" (31 cm) |
| ML52472 | 4 x 4 blunt prongs, 27 mm, side blade 5/8" (1.5 cm) deep, 12-1/4" (31 cm) |

## CERVICAL RETRACTOR SET

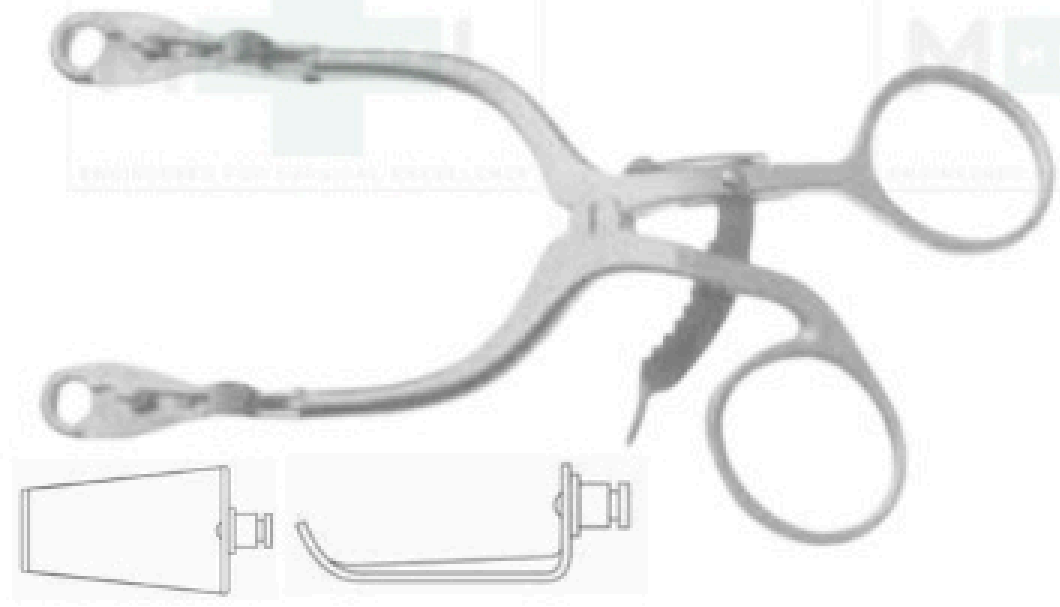

| CODE #  | DESCRIPTION                                |
|---------|--|
| ML55481 | Cervical retractor body, small, 6" (15 cm) |
| ML55482 | 25 mm deep blade, blunt                    |
| ML55483 | 30 mm deep blade, blunt                    |
| ML55484 | 35 mm deep blade, blunt                    |
| ML55485 | 40 mm deep blade, blunt                    |
| ML55486 | 45 mm deep blade, blunt                    |
| ML55487 | 50 mm deep blade, blunt                    |
| ML55488 | 55 mm deep blade, blunt                    |

## BECMLAN-EATON RETRACTOR



| CODE #  | DESCRIPTION                                     |
|---------|---|
| ML52476 | 7 x 7 sharp prongs, 40 x 48 mm, 12-1/4" (31 cm) |

## ADSON RETRACTOR

Hinged arm design.



| CODE #  | DESCRIPTION                     |
|---------|---------------------------------|
| ML52474 | 4 x 5 blunt prongs, 13" (33 cm) |

## BECMLAN-ADSON LAMINECTOMY RETRACTORS

4 x 4 prongs, hinged blades 25 mm high, 12-1/4" (31 cm).



| CODE #  | DESCRIPTION                              |
|---------|--|
| ML52484 | Blunt, 25 mm deep                        |
| ML52488 | Blunt, 44 mm deep, max. opening 6"       |
| ML52486 | Sharp, 44 mm deep                        |
| ML52490 | Sharp, 25 mm deep, max. opening 5-11/16" |

## VERTEBRA SPREADER (CLOWARD)



| CODE #  | DESCRIPTION  |
|---------|--|
| ML55490 | #1 with ratchet, 3/4" (19 mm) spread, 5" (12.5 cm) |

## BECMLAN-WEITLANER RETRACTORS

With hinged blades. Satin finish, 9-1/2" (24 cm).



| CODE #  | DESCRIPTION               |
|---------|---------------------------|
| ML52542 | 3 x 4 sharp prongs, 22 mm |
| ML52544 | 3 x 4 blunt prongs, 22 mm |

## VERTEBRAL BODY DISTRACTORS



| CODE #  | DESCRIPTION   |
|---------|---|
| ML55410 | Small   |
| ML55412 | Large, 11 mm wide x 3.8 mm deep jaws, 11-1/4" (28.5 cm) |

## HORIZONTAL RETRACTOR

Primarily used to retract detached trochanter from the stump of the femoral neck. Hinged arms allow handles to be angled away from surgical site to minimize interference.

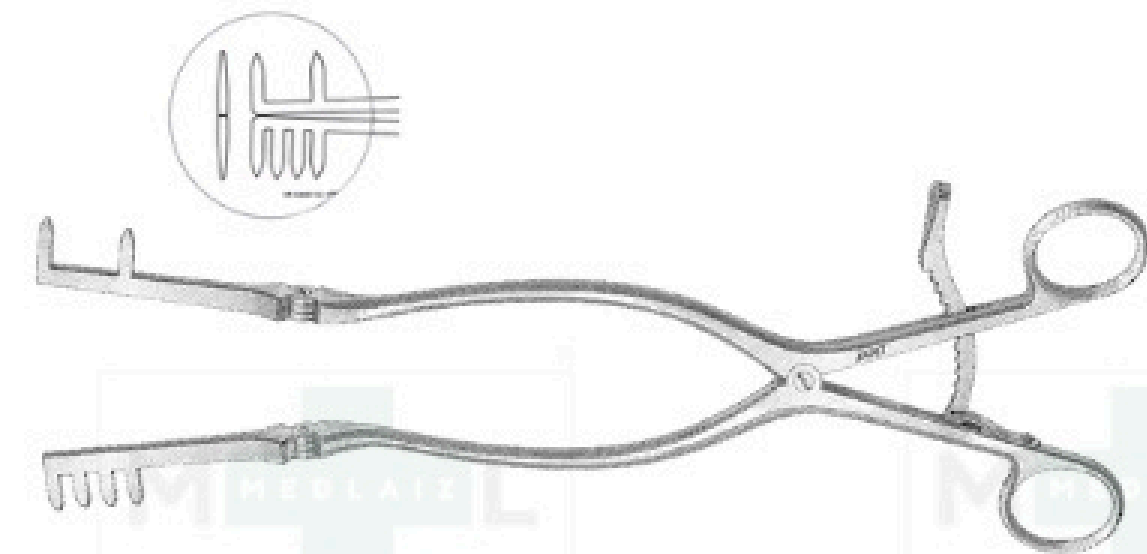

| CODE #  | DESCRIPTION  |
|---------|--|
| ML52602 | Hinged blades, 4 x 2 sharp prongs, 12-1/4" (31 cm) |

## SAXENA BONE GRAFTING RETRACTOR

- Ratchet is calibrated in millimeters to accurately assess how wide the lateral portion of the bone graft needs to be.
- Helpful in many types of procedures to accurately assess the amount of bone graft needed, such as for fusions and nonunions.



| CODE #  | DESCRIPTION                               |
|---------|---|
| ML48220 | 35 mm graduated ratchet, 6-1/2" (16.5 cm) |

## LUMBAR LAMINA SPREADERS

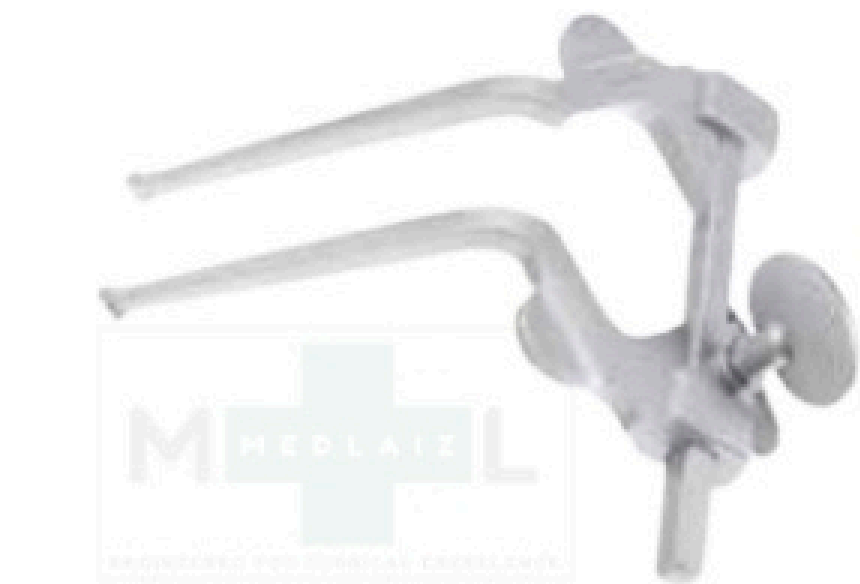

| CODE #  | DESCRIPTION                                      |
|---------|--|
| ML55495 | #1, arm length, 3-1/2" (9 cm), 5-1/4" (13.5 cm)  |
| ML55496 | #2, arm length, 4-1/4" (11 cm), 5-1/4" (13.5 cm) |

## INGE RETRACTOR

Available with or without teeth.



| CODE #  | DESCRIPTION                     |
|---------|---------------------------------|
| ML48217 | With teeth, 6-1/2" (16.5 cm)    |
| ML48218 | Without teeth, 6-1/2" (16.5 cm) |
| ML48230 | With teeth, 10-3/8" (26.5 cm)   |

## LAMINA SPREADERS



| CODE #  | DESCRIPTION                       |
|---------|-----------------------------------|
| ML48228 | Concave blades, 10-1/2" (26.5 cm) |
| ML48226 | Flat blades, 10-3/4" (27.5 cm)    |

## MEYERDING BLADES



| CODE #  | DESCRIPTION                        |
|---------|------------------------------------|
| ML55458 | 1" wide x 2 1/4" deep (25 x 57 mm) |
| ML55459 | 1" wide x 3" deep (25 x 76 mm)     |
| ML55460 | 2" wide x 3-1/4" deep (51 x 83 mm) |

## SCOVILLE BLADES

Solid.



| CODE #  | DESCRIPTION                               |
|---------|---|
| ML55451 | 1" wide x 2-1/2" deep (25 mm x 64 mm)     |
| ML55452 | 2" wide x 2-1/2" deep (51 mm x 64 mm)     |
| ML55453 | 1-1/8" wide x 2-5/8" deep (29 mm x 67 mm) |
| ML55454 | 1" wide x 3-1/2" deep (25 mm x 89 mm)     |

## SCOVILLE HEMILAMINECTOMY RETRACTOR BODY



| CODE #  | DESCRIPTION                                      |
|---------|--|
| ML55445 | Spread 6-3/4" (17 cm), arm length 5-1/2" (14 cm) |

## SCOVILLE-HAVERFIELD RETRACTOR BLADE



| CODE #  | DESCRIPTION |
|---------|-------------|
| ML55455 | 1" x 3-1/2" |

## HAVERFIELD-SCOVILLE HEMILAMINECTOMY RETRACTOR BODY



| CODE #  | DESCRIPTION                 |
|---------|-----------------------------|
| ML55446 | Body only, 8-3/8" (21.5 cm) |

# INITIAL INCISION (CHARNLEY) RETRACTOR

Used primarily for hip procedures

| CODE #   | DESCRIPTION  |
|----------|--|
| ML52704  | 4 sharp prongs, stainless steel, maximum retraction width 9-3/4" (24.5 cm), prong depth 1-1/4" (32 mm), blade width 1" (25 mm), weight 3 lbs. Other blades are available |
| ML52704F | Frame only   |
| ML52704S | S Short blade, 1-1/4" deep x 1" wide (34 x 25 mm)  |
| ML52705S | Short blade, 2" deep x 1" wide (51 x 25 mm)  |
| ML52706S | Short blade, 2-1/4" deep x 1" wide (57 x 25 mm)  |
| ML52707S | Short blade, 2-1/2" deep x 1" wide (64 x 25 mm)  |
| ML52708S | Short blade, 3" deep x 1" wide (77 x 25 mm)  |
| ML52709S | Short blade, 4" deep x 1" wide (102 x 25 mm)   |
| ML52711S | Short blade, 5" deep x 1" wide (127 x 25 mm)   |
| ML52704L | Long blade, 1-1/4" deep x 1" wide (34 x 25 mm)   |
| ML52705L | Long blade, 2" deep x 1" wide (51 x 25 mm)   |
| ML52706L | Long blade, 2-1/4" deep x 1" wide (57 x 25 mm)   |
| ML52707L | Long blade, 2-1/2" deep x 1" wide (64 x 25 mm)   |
| ML52708L | Long blade, 3" deep x 1" wide (77 x 25 mm)   |
| ML52709L | Long blade, 4" deep x 1" wide (102 x 25 mm)  |
| ML52711L | Long blade, 5" deep x 1" wide (127 x 25 mm)  |



## HIBBS BLADES



| CODE #  | DESCRIPTION                            |
|---------|--|
| ML55461 | 1" wide x 2" deep (25 x 51 mm)         |
| ML55463 | 1" wide x 2-1/2" deep (25 x 64 mm)     |
| ML55465 | 1" wide x 3" deep (25 x 76 mm)         |
| ML55468 | 1" wide x 4" deep (25 x 102 mm)        |
| ML55464 | 1-1/2" wide x 2-1/2" deep (38 x 64 mm) |
| ML55466 | 1-1/2" wide x 3" deep (38 x 76 mm)     |
| ML55462 | 2" wide x 2" deep (51 x 51 mm)         |
| ML55467 | 2" wide x 3" deep (51 x 76 mm)         |
| ML55469 | 2" wide x 4" deep (51 x 102 mm)        |

## SCOVILLE BLADES

4-prong



| CODE #  | DESCRIPTION                            |
|---------|--|
| ML55456 | 1-1/2" wide x 1-5/8" deep (38 x 41 mm) |
| ML55457 | 1-7/8" wide x 2-5/8" deep (48 x 67 mm) |

## TAYLOR SPINAL BLADES



| CODE #  | DESCRIPTION                         |
|---------|-------------------------------------|
| ML55471 | 1-1/4" wide x 3" deep (32 x 76 mm)  |
| ML55472 | 1-1/4" wide x 4" deep (32 x 102 mm) |

## TAYLOR LAMINECTOMY BLADE



| CODE #  | DESCRIPTION                                      |
|---------|--|
| ML55473 | 3 prongs, 1-1/2" wide x 1-3/4" deep (38 x 44 mm) |

## TAYLOR LAMINECTOMY BLADES

4-prong



| CODE #  | DESCRIPTION                            |
|---------|--|
| ML55474 | 2" wide x 1-7/8" deep (51 x 48 mm)     |
| ML55476 | 2-1/4" wide x 3-1/8" deep (57 x 79 mm) |
| ML55475 | 2-1/2" wide x 2-1/2" deep (64 x 64 mm) |

# SCOVILLE BLADES

Hook style.



| CODE #  | DESCRIPTION                        |
|---------|------------------------------------|
| ML55447 | 2" deep (51 mm)                    |
| ML55448 | 3" deep (76 mm)                    |
| ML55449 | 2" deep (51 mm) with cross bar     |
| ML55450 | 2-3/4" deep (70 mm) with cross bar |

# FRAZIER LAMINECTOMY RETRACTOR



| CODE #  | DESCRIPTION   |
|---------|---|
| ML52702 | 3 x 4 blunt prongs, spread 3-1/2" (9 cm), arm length 5" (12.5 cm) |

# CRUTCHFIELD TONGS



| CODE #  | DESCRIPTION                       |
|---------|-----------------------------------|
| ML48249 | With two drills, 4-7/8" (12.5 cm) |